



Pressure Washer Operator's Manual



THIS MANUAL CONTAINS IMPORTANT INFORMATION REGARDING SAFETY, OPERATION, MAINTENANCE AND STORAGE OF THIS PRODUCT. BEFORE USE, READ CAREFULLY AND UNDERSTAND ALL CAUTIONS, WARNINGS, INSTRUCTIONS AND PRODUCT LABELS. FAILURE TO DO SO COULD RESULT IN SERIOUS PERSONAL INJURY AND/OR PROPERTY DAMAGE.

TABLE OF CONTENTS

SAFETY

Equipment Description.....	1
Safety Symbols And Meanings.....	1
Operation Precautions.....	1
Safety Precautions.....	2
Pressure Washer Components.....	9

SET UP

Pressure Washer Components.....	9
Assembly.....	10
General Information.....	11
Pre-start Checks.....	12

OPERATION

Pre-start Checks.....	12
Starting the Engine.....	13
Pressure Washer Operation.....	14
Stopping the Engine and Pressure Washer.....	16
High Altitude Operation.....	16
Adding Engine Oil	19

MAINTENANCE

Engine Maintenance Schedule.....	17
Pump Maintenance	18
Cleaning Pressure Washer	19
Cleaning Engine Oil	19
Adding Engine Oil	19
Spark Plug Maintenance	20
Air Filter Maintenance	20
Long-term Storage	20
Trouble Shooting	22

PARTS LIST AND DIAGRAM

General Assembly Diagram	25
General Parts List.....	26

SPECIFICATIONS

Pressure Specifications.....	27
------------------------------	----

WARRANTY

Warranty.....	28
---------------	----

SAFETY

Equipment Description



Read this manual carefully and become familiar with your pressure washer. Know its applications, its limitations, and any hazards involved.

This pressure washer operates at 4,400 PSI and a flow rate of 15.1 Litres per minute. This high quality residential system features 8" wheels, triplex pump with stainless steel pistons, automatic cool down system, quick connect spray tips, heavy duty 15m hose, and more.

Every effort has been made to ensure that information in this manual is accurate and current. However, we reserve the right to change, alter, or otherwise improve the product and this document at any time without prior notice.

Safety symbols and Meanings



Operator's Manual



Toxic Fumes
Toxic Fumes



Electrical Shock



Slippery Surface



Fall



Fluid Injection
Fluid Injection



Fire



Explosion



Kickback



Projectile



Moving Parts



Flying Objects



Chemical Burn



Hot Surface

▲ The safety alert symbol indicates a potential personal injury hazard. A signal word (DANGER, WARNING, or CAUTION) is used with the alert symbol to designate a degree or level of hazard seriousness. A safety symbol may be used to represent the type of hazard. The signal word NOTICE is used to address practices not related to personal injury.

▲ DANGER indicates a hazard which, if not avoided, will result in death or serious injury.

▲ WARNING indicates a hazard which, if not avoided, could result in death or serious injury.

▲ CAUTION indicates a hazard which, if not avoided, could result in minor or moderate injury.

NOTICE address practices not related to personal injury.

Operation Precautions

▲ WARNING POISONOUS GAS HAZARD. Engine
 Engine exhaust contains carbon monoxide, a poisonous gas that could kill you in minutes. You CANNOT smell it, see it, or taste it. Even if you do not smell exhaust fumes, you could still be exposed to carbon monoxide gas.

Some chemicals or detergents could be harmful if inhaled or ingested, resulting in death, serious injury, nausea, fainting or poisoning.

- Operate this product ONLY outside far away from windows, doors and vents to reduce the risk of carbon monoxide gas from accumulating and potentially being drawn towards occupied spaces.
- DO NOT run this product inside homes, garages, basements, crawlspaces, sheds, or other partially-enclosed spaces even if using fans or opening doors and windows for ventilation. Carbon monoxide can quickly build up in these spaces and can linger for hours, even after this product has shut off.
- ALWAYS place this product downwind and point the engine exhaust away from occupied spaces.

If you start to feel sick, dizzy, or weak while using this product, shut it off and get to fresh air RIGHT AWAY. See a doctor. You may have carbon monoxide poisoning.

- Use a respirator or mask whenever there is a chance that vapors may be inhaled when using chemicals.
- Read all instructions with care so you are certain the mask will provide the necessary protection against inhaling harmful vapors when using chemicals.

▲ DANGER

Using an pressure washer indoors **CAN KILL YOU IN MINUTES**. Pressure washer exhaust contains carbon Monoxide. This is a poison you cannot see or smell.



NEVER use inside a home or garage, **EVEN IF** doors and windows are open.

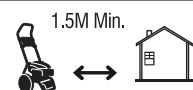

Only use **OUTSIDE** and far away from windows, doors, and vents.

SAFETY

SAFETY PRECAUTIONS

⚠ DANGER

Using an pressure washer indoors **CAN KILL YOU IN MINUTES**. Pressure washer exhaust contains carbon Monoxide. This is a poison you cannot see or smell.



NEVER use inside a home or garage, **EVEN IF** doors and windows are open.

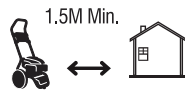

Only use **OUTSIDE** and far away from windows, doors, and vents.

⚠ WARNING

POISONOUS GAS HAZARD.



Engine exhaust contains carbon monoxide, a poisonous gas that could kill you in minutes. You **CANNOT** smell it, see it, or taste it. Even if you do not smell exhaust fumes, you could still be exposed to carbon monoxide gas.

- Operate this product **ONLY** outside far away from windows, door, and vents to reduce the risk of carbon monoxide gas from accumulating and potentially being drawn towards occupied spaces.
- Install battery-operated carbon monoxide alarms or plug-in carbon monoxide alarms with battery back-up according to the manufacturer's instructions. Smoke alarms cannot detect carbon monoxide gas.
- **DO NOT** run this product inside homes, garages, basements, crawlspaces, sheds, or other partially-enclosed spaces even if using fans or opening doors and windows for ventilation. Carbon monoxide can quickly build up in these spaces and can linger for hours, even after this product has shut off.
- **ALWAYS** place this product downwind and point the engine

dizzy, or weak while using this product, shut it off and get to fresh air **RIGHT AWAY**. See a doctor. You may have carbon monoxide poisoning.

⚠ WARNING

The engine exhaust from this product contains chemicals known to the State of California to cause cancer, birth defects, or other reproductive harm.

⚠ WARNING

Certain components in this product and related accessories contain chemicals known to the state of California to cause cancer, birth defects or other reproductive harm. Wash hands after handling.

- If you start to feel sick, dizzy or weak while using the pressure washer, you may have carbon monoxide poisoning. Get outside to fresh air immediately and call 000 for emergency medical attention. Very high levels of CO can rapidly cause victims to lose consciousness before they can rescue themselves. **DO NOT** attempt to shut off the pressure washer before moving to fresh air. Entering an enclosed space where a pressure washer is or has been running may put you at greater risk of CO poisoning.

SAFETY

⚠ WARNING



Starter cord kickback (rapid retraction) will pull hand arm toward engine faster than you can let go which could cause broken bones, fractures, bruises, or sprains resulting in serious injury.

- When starting engine, pull cord slowly until resistance is felt and then pull rapidly to avoid kickback.

⚠ WARNING



Fuel and its vapors are extremely flammable and explosive which could cause burns, fire, or explosion resulting in death or serious injury and/or property damage.

WHEN ADDING OR DRAINING FUEL

- Turn pressure washer engine OFF and let it cool at least 2 minutes before removing fuel cap.
- Fill or drain fuel tank outdoors.
- **DO NOT** overfill tank. Allow space for fuel expansion.
- IF fuel spills, wait until it evaporates before starting engine.
- Keep fuel away from sparks, open flames, pilot lights, heat, and other ignition sources.
- Check fuel lines, tank, cap, and fittings frequently for cracks or leaks. Replace if necessary.
- **DO NOT** light a cigarette or smoke.

WHEN STARTING EQUIPMENT

- Ensure spark plug, muffler fuel cap, and air cleaner are in place.
- **DO NOT** crank engine with spark plug removed.

WHEN OPERATING EQUIPMENT

- **DO NOT** operate this product inside any building, carport, porch, mobile equipment, marine applications, or enclosure.
- **DO NOT** tip engine or equipment at angle which causes fuel to spill.
- **DO NOT** stop engine by moving choke control to "Start" position.

WHEN TRANSPORTING, MOVING OR REPAIRING EQUIPMENT

- Transport/move/repair with fuel tank EMPTY or with fuel shutoff valve OFF.
- **DO NOT** tip engine or equipment at angle which causes fuel to spill.
- Disconnect spark plug wire.

WHEN STORING FUEL OR EQUIPMENT WITH FUEL IN TANK

- Store away from furnaces, stoves, water heaters, clothes dryers, or other appliances that have pilot light or other ignition source because they could ignite fuel vapors.

SAFETY

WARNING



Exhaust heat/gases could ignite combustibles, structures or damage fuel tank causing a fire, resulting in death or serious injury and/or property damage.

Contact with muffler area could cause burns resulting in serious injury.

- **DO NOT** touch hot parts and **AVOID** hot exhaust gases.
- Allow equipment to cool before touching.
- Replacement parts must be the same and installed in the same position as the ordinary parts.

WARNING



Unintentional sparking could cause fire or electric shock resulting in death or serious injury.

WHEN ADJUSTING OR MAKING REPAIRS TO YOUR PRESSURE WASHER

- Disconnect the spark plug wire from the spark plug and place the wire where it cannot contact spark plug.

WHEN TESTING FOR ENGINE SPARK

- Use approved spark plug tester.
- **DO NOT** check for spark with spark plug removed.

WARNING



Starter and other rotating parts could entangle hands, hair, clothing, or accessories resulting in serious injury.

- **NEVER** operate pressure washer without protective housing or covers.
- **DO NOT** wear loose clothing, jewelry or anything that could be caught in the starter or other rotating parts.
- Tie up long hair and remove jewelry.

WARNING

Excessively high operating speeds could result in minor injury.

- **DO NOT** tamper with governor spring, links or other parts to increase engine speed.
- **DO NOT** modify pressure washer in any way.

SAFETY

NOTE:

Improper treatment of pressure washer could damage it and shorten its life.

- Use pressure washer only for intended uses.
- If you have questions about intended use, ask dealer or contact local service center.
- DO NOT insert any objects through cooling slots.

WARNING

Medical and Life Support Uses.

- In case of emergency, call 000 immediately.

SAFETY

WARNING



Exhaust heat/gases could ignite combustibles, structures or damage fuel tank causing a fire, resulting in death or serious injury.

Contact with muffler area could cause burns resulting in serious injury.

- **DO NOT** touch hot parts and **AVOID** hot exhaust gases.
- Keep at least 5 feet (1.5m) of clearance on all sides of pressure washer including overhead.
- Replacement parts must be the same and installed in the same position as the original parts.

WARNING



- **NEVER** spray near power source.

WARNING



Use of pressure washer could create puddles and slippery surfaces causing you to fall resulting in death or serious

injury. Kickback from spray gun could cause you to fall resulting in death or serious injury.

- The cleaning area should have adequate slopes and drainage to reduce the possibility of a fall due to slippery surfaces.
- Be extremely careful if you must use the pressure washer from a ladder, scaffolding, or any other similar location.
- Firmly grasp spray gun with both hands when using high pressure spray to avoid injury when spray gun kicks back.

WARNING



Chemical Burn Hazard. Chemicals could cause burns resulting in death or serious injury.

- **DO NOT** use caustic liquid with pressure washer.
- Use **ONLY** pressure washer safe detergents/soaps. Follow all manufacturers instructions.

WARNING



Fuel and its vapors are extremely flammable and explosive which could cause burns, fire or explosion resulting in death or serious injury.

WHEN ADDING OR DRAINING FUEL

- Turn pressure washer engine OFF and let it cool at least 2 minutes removing fuel cap. Loosen cap slowly to relieve pressure in tank.
- Fill or drain fuel tank outdoors.
- **DO NOT** overfill tank. Allow space for fuel expansion.
- If fuel spills, wait until evaporates before starting engine.
- Keep fuel away from sparks, open flames, pilot lights, heat, and other ignition sources.
- Check fuel lines, tank, cap and fittings frequently for cracks or leaks. Replace if necessary.
- **DO NOT** light a cigarette or smoke.

WHEN STARTING EQUIPMENT

- Ensure spark plug, muffler, fuel cap, and air filter are in place.
- **DO NOT** crank engine with spark plug removed.

WHEN OPERATING EQUIPMENT

- **DO NOT** operate this product inside any building, carport, porch, mobile equipment, marine applications, or enclosure.
- **DO NOT** tip engine or equipment at angle which causes fuel to spill.
- **DO NOT** spray flammable liquids.

SAFETY

WHEN TRANSPORTING, MOVING OR REPAIRING EQUIPMENT

- Transport/move/repair with fuel tank EMPTY or with fuel shutoff valve OFF.
- DO NOT tip engine or equipment at angle which causes fuel to spill.
- Disconnect spark plug wire.

WHEN STORING FUEL OR EQUIPMENT WITH FUEL IN TANK

- Store away from furnaces, stoves, water heaters, clothes dryers, or other appliances that have pilot light or other ignition source because they could ignite fuel vapors.

 **WARNING** Starter cord kickback (rapid retraction) will pull hand and arm toward engine faster than you can let go which could cause broken bones, fractures, bruises, or sprains resulting in serious injury.

- NEVER pull starter cord without first relieving spray pressure.
- When starting engine, pull cord slowly until resistance is felt and then pull rapidly to avoid kickback. 
- After each starting attempt, where engine fails to run, always point spray gun in safe direction, disengage trigger lock and squeeze spray gun trigger to release high pressure.
- Firmly grasp spray gun with both hands when using high pressure spray to avoid injury when spray gun kicks back.

 **WARNING** The high pressure stream of water that this equipment produces could cut through skin and its underlying tissues, resulting in serious injury and possible amputation.

Spray gun traps high water pressure, even when engine is stopped and water is disconnected, which could result in serious injury.

- If cut by fluid, call physician immediately. DO NOT treat as a simple cut.
- DO NOT allow CHILDREN to operate pressure washer.
- NEVER repair high pressure hose. Replace it.
- NEVER repair leaking connections with sealant of any kind. Replace o-ring or seal.
- NEVER connect high pressure hose to nozzle extension.
- Keep high pressure hose connected to pump and spray gun while system is pressurized.
- ALWAYS point spray gun in safe direction, disengage trigger lock and squeeze spray gun trigger to release high pressure every time you stop engine.
- NEVER aim spray gun at people, animals, or plants.

- DO NOT secure spray gun in open position.
- DO NOT leave spray gun unattended while machine is running.
- NEVER use a spray gun which does not have a trigger lock or trigger guard in place and in working order.
- Always be certain spray gun, nozzles and accessories are correctly attached.

 **WARNING** Unintentional sparking could cause fire or electric shock resulting in death or serious injury.





WHEN ADJUSTING OR MAKING REPAIRS TO YOUR PRESSURE WASHER

- Disconnect the spark plug wire from the spark plug and place the wire where it cannot contact spark plug.

WHEN TESTING FOR ENGINE SPARK

- Use approved spark plug tester.
- DO NOT check for spark with spark plug removed.

 **WARNING** Starter and other rotating parts could entangle hands, hair, clothing, or accessories resulting in serious injury.



- NEVER operate pressure washer without protective housing or covers.
- DO NOT wear loose clothing, jewelry or anything that could be caught in the starter or other rotating parts.
- Tie up long hair and remove jewelry.

 **WARNING** Risk of eye or bodily injury. Spray could splash back or propel objects resulting in serious injury.



- Always wear indirect vented (chemical splash) safety goggles marked to comply with ANSI Z87.1 when using or vicinity of this equipment.
- NEVER substitute safety glasses or dry-condition goggles for indirect vented safety goggles.
- Always wear protective clothing such as a long-sleeved shirt, long pants and close-toed shoes.
- NEVER operate pressure washer when barefoot or wearing sandals or shorts.

SAFETY

⚠ CAUTION Excessively high operating speeds could result in minor injury.

Excessively low speeds impose a heavy load.

- DO NOT tamper with governor spring, links or other parts to uncrease engine speed. Pressure washer supplies correct rated pressure and flow when running at governed speed.
- DO NOT modify pressure washer in any way.

NOTICE High pressure spray could damage fragile items including glass.

- DO NOT point spray gun at glass when using red (0°) nozzle.
- NEVER aim spray gun at plants.

NOTICE Improper treatment of pressure washer could damage it and shorten its life.

- NEVER operate units with broken or missing parts, or without protective housing or covers.
- DO NOT by-pass any safety device on this machine.
- DO NOT operate pressure washer above rated pressure.
- Before starting pressure washer in cold weather, check all parts of the equipment to be sure ice has formed there.
- NEVER move machine by pulling on hoses. Use handle providee on unit.

SET UP

 Read the entire "SAFETY" section at the beginning of this manual including all text under sunheadings therein before set up or use of this product.

WARNING

TO PREVENT SERIOUS INJURY: Operate only with proper spark arrestor installed.



Operation of this equipment may create sparks that can start fires around dry vegetation. A spark arrestor may be required.

The operator should contact local fire agencies for laws or regulations relating to fire prevention requirements.

TO PREVENT SERIOUS INJURY FROM ACCIDENTAL STARTING: Turn the Engine Switch of the equipment to its "OFF" position, wait for the engine to cool, and unplug the spark plug wire(s) before assembling or making any adjustments to the equipment.

Pressure Washer Components



Accessories Included

- 1 Oil Funnel
- 1 Engine Oil
- 1 Owner's Manual
- 1 Spark Plug Socket
- 1 Nozzle Cleaning Needle

SET UP

Assembly

1. Insert 4 bolts(A) through holes in the foot bracket(C) the lower frame(B) as shown, thread lock 4 nuts(D) onto bolts and tighten one full turn past snug.

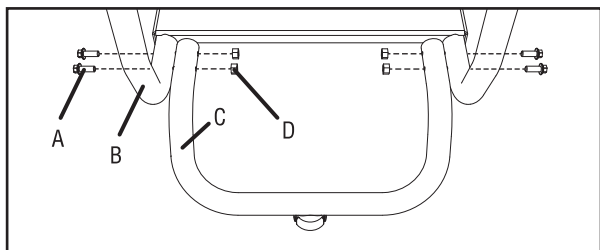

2. Raise the end of the machine high enough to gain access to the frame bottom, slide the axle(A) through the hole in the center of the wheel(B) and the wheel mounting hole(C), insert hitch pin(D) to secure.

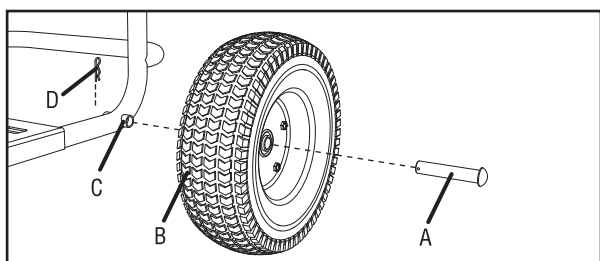

3. Slide the 4 bolts(A) through holes in the gun holder(B), thread locked to the handle(C) and tighten one full turn past snug.

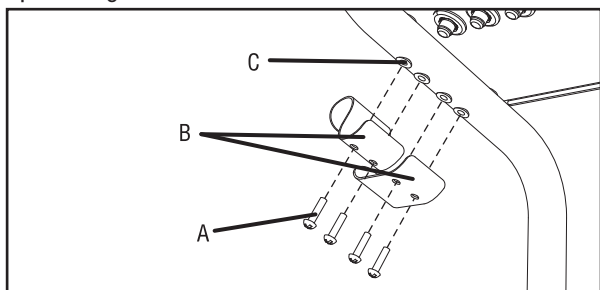

4. Insert the hose holder(A) through holes in the handle(B), thread lock 1 nut(C) onto one end of holder and tighten one full turn past snug.

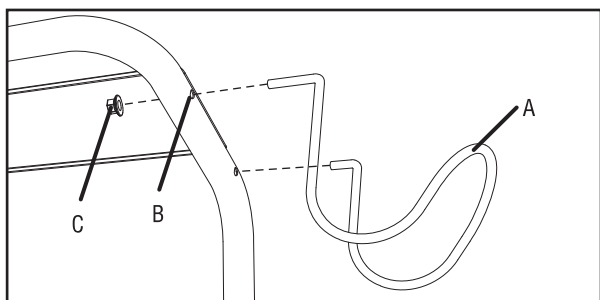

5. Push and hold the button on the frame(B) as you slide the handle(A) into the holes in the frame.

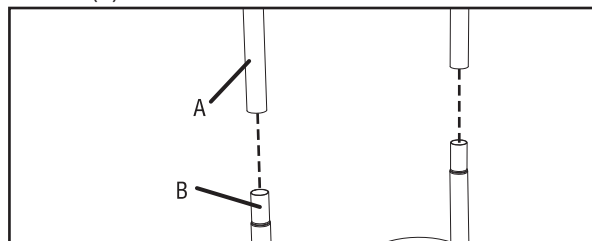

6. Replace red shipping plug(A) on the pump(B) with the supplied yellow dipstick(C).

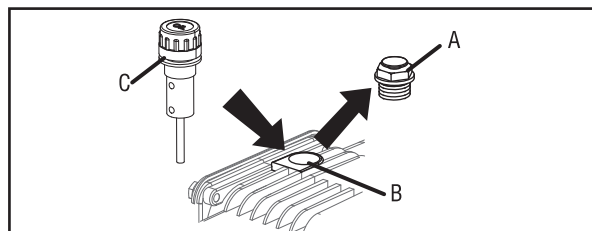

7. Remove the protective cap on the wand inlet, insert the wand(A) into the spray gun tip and tighten the nut(B) firmly by hand.

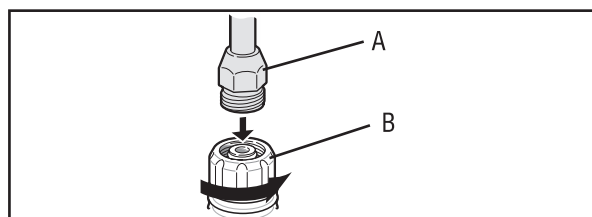

8. To connect or disconnect spray nozzle(A), pull back the quick-connect collar(B) of wand(C) and insert the nozzle(A) and then release the quick-connect collar(B). Once the nozzle is connected, pull on the nozzle to make sure it is firmly attached.

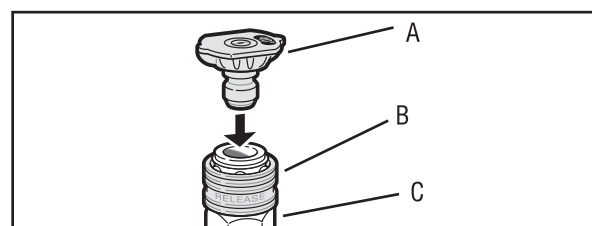

9. Attach high pressure hose(D) to the gun(A), pull back the quick-connect collar(C) of hose and insert the spray gun connector(B) and then release the quick-connect collar(C). Once the hose is connected, pull on the hose to make sure it is firmly attached.

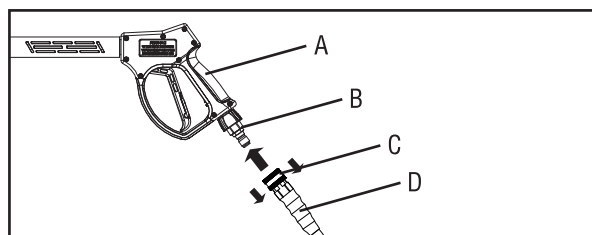

SET UP

10. Attach high pressure hose(A) to the pump(D), pull back the quick-connect collar(C) of pump, insert hose connector(B) and then release the quick-connect collar, pull on the hose to make sure it is firmly attached.

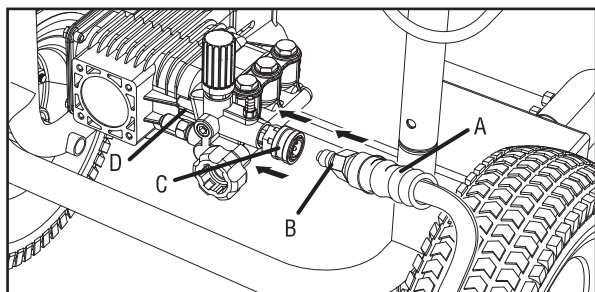

11. Run water through the hose for 30 seconds to flush any debris from the hose, inspect inlet screen and remove any debris, connect hose to water inlet and tighten by hand. Turn on water, purge the system's pump of air by releasing the safety and squeezing the trigger of the spray gun.

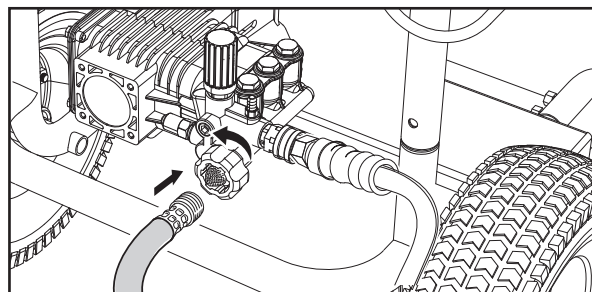

General Information

Fuel	<ul style="list-style-type: none"> • Use fresh high quality unleaded petrol (minimum 87 octane) • Add stabilizer (not supplied) to fuel tank and run engine for 5 minutes before storage.
Oil	<ul style="list-style-type: none"> • Engine oil: Use only SAE 10W-30.
Water Pressure Pump	<ul style="list-style-type: none"> • Use only cold water. • Do not operate pressure washer with clogged or missing water filter screen. • Do not operate pressure washer without adequate water supply.
Pressure Adjustment	<ul style="list-style-type: none"> • Pressure setting is pre-set at factory. • For lowering pressure, refer to "Pressure Adjustment".
Pressure Pump	<ul style="list-style-type: none"> • Squeeze spray gun trigger every 2 minutes while engine is running. • Do not allow water to freeze in pump.
By-Pass Mode By-Pass Mode	<ul style="list-style-type: none"> • Never leave unit running for more than 2 minutes without squeeze spray gun trigger. Doing so could damage pump and void warranty.
Thermal Relief Valve	<ul style="list-style-type: none"> • Pump is equipped with a thermal relief valve. If water overheats, this valve opens releasing gush of water. Afterwards, the valve closes returning pump to normal operation.
Pressure Hose	<ul style="list-style-type: none"> • Do not allow hoses to come in contact with engine muffler during use or immediately after use. • DO NOT pull unit by pressure hose.
Engine	<ul style="list-style-type: none"> • Add stabilizer (not supplied) to fuel tank and let engine run for 5 minutes before storage. • Always turn on water before starting engine.
Soap/Chemicals	<ul style="list-style-type: none"> • Use only soaps and chemicals detergents designed for pressure washer use.
Nozzle	<ul style="list-style-type: none"> • Always keep nozzles unclogged. Use the nozzle needle to clean if clogged. • Use ONLY detergent nozzle(black) when using chemical and cleaning solvents.
Storage or Winterizing	<ul style="list-style-type: none"> • Run clean water through chemical inlet. • Add stabilizer to any remaining fuel in fuel tank. • Do not allow water to freeze in pressure pump, spray gun, spray wand or hoses.

OPERATION



Read the entire "SAFETY" section at the beginning of this manual including all text under subheadings therein before set up or use of this product
Improper treatment of Pressure Washer can damage internal components and shorten the life of unit. Failure to follow this warning will void warranty.

Pre-Start Checks

Inspect engine and equipment looking for damaged, loose and missing parts before set up and starting. If any problems are found, do not use equipment until fixed properly.

1. Adding Engine Oil

NOTICE Your Warranty is VOID if the engine's crankcase is not properly filled with oil before each use. Before each use, check the oil level.

Engine will not start with low or no engine oil.

- 1.1 Move the Pressure Washer OUTSIDE and place on a flat and level surface.
- 1.2 Make sure the engine is stopped and is level.
- 1.3 Close the Fuel Valve.
- 1.4 Clean the top of the Dipstick and the area around.
Remove the Dipstick by turning it counterclockwise, and wipe it off with a clean, lint free rag.
- 1.5 Place funnel in the oil reservoir.
- 1.6 Pour engine oil (SAE 10W-30 is recommended for general use) until oil level reaches the threads inside the oil reservoir.
DO NOT overfill.

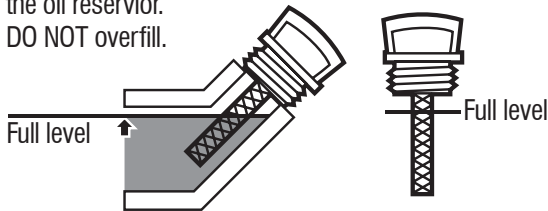

- 1.7 Reinsert the Dipstick without threading it in and remove in to check the oil level. The oil level should be up to the full level as shown above.
- 1.8 If the oil level is at or below the low mark, add the appropriate type of oil until the level is at the proper level. (The SAE Viscosity Grade Chart on page 16 in the "MAINTENANCE" section shows other viscosities to use in different average temperatures.)
- 1.9 Replace the dipstick and fully tighten.

NOTICE :

Do not run the engine with too little oil
Engine will shut off if engine oil level is too low.

2. Adding Fuel



! Fuel and fuel vapor are extremely flammable flammable and explosive. Fire or explosion from misuse of fuel can cause severe burns and even death. Failure to use fuel as recommended in this manual will void the warranty.

Fill the fuel tank in a well-ventilated area away from ignition sources. If the engine is hot from use, shut the engine off and wait for it to cool before adding fuel.

Do not smoke.

NOTICE :

Do not use petrol that has been stored in a metal fuel container or a dirty fuel container. It can cause particles to enter the carburetor, affecting engine performance and/or causing damage.

- 2.1 Move the Pressure Washer OUTSIDE and place on a flat and level surface.
- 2.2 Clean the Fuel Cap and the area around it.
- 2.3 Unscrew and remove the Fuel Cap.
- 2.4 Remove the Strainer and remove any dirt and debris.
Then replace the Strainer.
- 2.5 If needed, fill the Fuel Tank to about 1 inch under the fill neck of the Fuel Tank with 87 octane or higher unleaded gasoline that has been treated with a fuel stabilizer additive. Follow fuel stabilizer manufacturer's recommendations for use.
- 2.6 Then replace the Fuel Cap.
- 2.7 Wipe up any spilled fuel and allow excess to evaporate before starting engine. To prevent FIRE, do not start the engine while the smell of fuel hangs in the air.

NOTICE :

When adding fuel to pressure washer, observe the following:

DO NOT use unapproved petrol such as E85 (85% ethanol/ 15% gasoline).

DO NOT mix oil with petrol .

DO NOT modify engine to run on alternate fuels. Turn pressure before removing fuel cap. Loosen fuel cap slowly to release pressure. Keep fuel away from sparks, open flames, pilot lights, heat and other ignition sources.

DO NOT light a cigarette or smoke near open flames, pilot lights, heat and other ignition sources.

DO NOT light a cigarette or smoke near open fuel tank or container.

Clean area around fuel fill cap and slowly remove cap to allow any pressure to escape.

Install fuel cap and allow any spilled fuel to evaporate before starting engine.

OPERATION

Pre-Start Checks(Continued)

3. Lubrication O-Rings

Lubrication of o-rings is extremely important for installation and operation. The use of a lubricant (petroleum or synthetic grease) during assembly helps seat o-rings properly and provides an improved seal. It also helps protect the o-ring from damage by abrasion, pinching or cutting and extends the life of the o-ring.

NOTICE ALWAYS apply a small amount of lubricant on o-rings prior to assembling the garden hose to the pump inlet(A), high pressure hose to pump outlet (B), high pressure hose (C), nozzle extension(D), and spray gun(E).

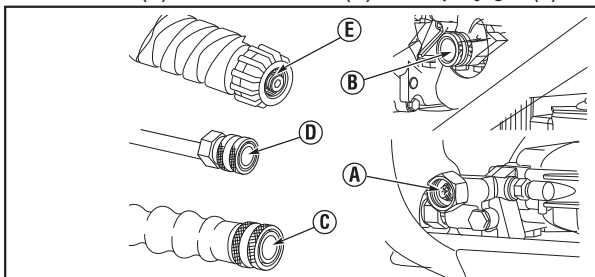

Lubricate all connections shown below, following these instructions:

- 3.1 Inspect and clean connecting surfaces prior to lubrication and assembly.
- 3.2 Use lubricants sparingly during assembly; a light film is all that is required.
- 3.3 Use a small brush or cotton swab to apply grease directly to o-rings where they are not accessible (QC fitting, M22 fitting).

Starting The Engine

WARNING

- Inspect the equipment and engine.
- Fill the engine with the proper amount and type of both stabilizer-treated unleaded petrol and oil.
TURN ON WATER SUPPLY, REMOVE NOZZLE, POINT WAND IN SAFE DIRECTION, AND HOLD DOWN TRIGGER UNTIL ALL AIR IS RELEASED FROM THE SYSTEM, AT LEAST 30 SECONDS.

Then release the Trigger, lock it in the safety position and replace Nozzle before starting engine.

1. To start a cold engine, move the Choke to the START position. To restart a warm engine, leave the Choke in the RUN position.

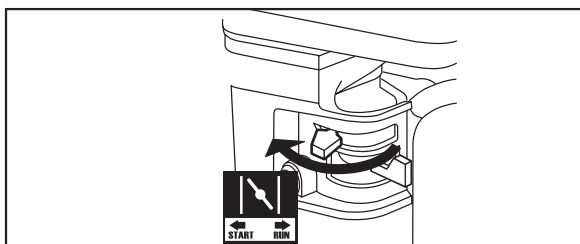

2. Move the Fuel Valve to the "ON" position.

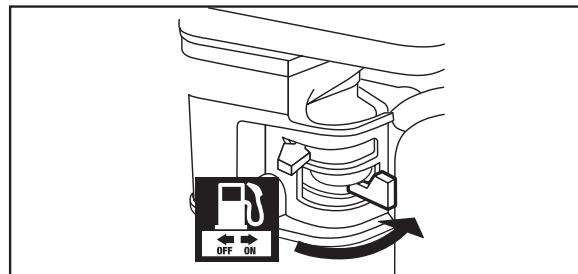

3. Turn the Engine Switch on.

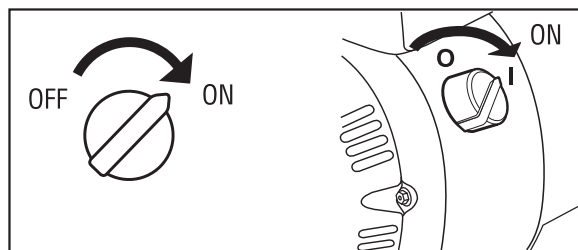

NOTICE :

If engine does not start, check engine oil level. Engine will not start with low or no engine oil.

4. Grip the Starter Handle of the Engine loosely and pull it slowly two times to allow the gasoline to flow into the Engine's carburetor. Then pull the Starter Handle gently until resistance is felt. Allow Cable to retract fully and then pull quickly. Repeat until the engine starts.

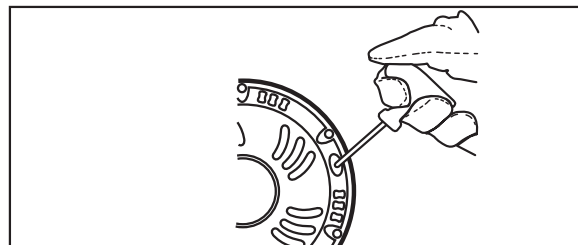

NOTICE :

Do not let the Starter Handle snap back against the engine. Hold it as it recoils so it doesn't hit the engine.

5. Allow the Engine to run several seconds. Then, if the Choke lever is in the START position, move the Choke Lever very slowly to its RUN position.

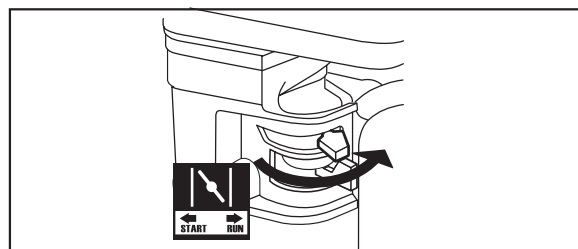

NOTICE :

Moving the Choke Lever too fast could stall the engine.

OPERATION

Pressure Washer Operation

⚠ WARNING

Do not direct spray from the Pressure Washer at a person or an animal.

The water stream could cause serious injury.

Do not leave Pressure Washer in bypass mode for more than 2 minutes at a time. Water temperature inside the pressure pump will rise to a dangerous level resulting in damage to the internal components of the pump. Failure to follow this warning will void warranty.

Do not run the pressure pump without the water supply connected and turned on. Damage to the Pressure Washer resulting from failure to follow instruction will void warranty. ALWAYS wear approved safety glasses when operating Pressure Washers. Spray can splash back or propel objects, including incorrectly attached accessories.



The high pressure stream of water that this equipment produces can cut through skin and its underlying tissues, leading to possible amputation. Spray gun

traps high water pressure, even when the motor is stopped and water is disconnected, which can cause injury.

Kickback from spray gun can cause you to fall.



⚠ CAUTION

Use the pressure Washer only OUTSIDE in a fully VENTILATED area, place the pressure Washer on surfaces able to withstand the force of the spray.

1. Selecting the Right Nozzle

To prevent damage to your surface and to select an appropriate nozzle size for your application, always start with lowest pressure nozzle size (Green) and continue to the higher nozzle size until the best work result is achieved.

The pressure Washer comes furnished with five spray nozzles. Each nozzle is color coded and delivers a specific spray pattern and pressure for a particular cleaning job. The size of the nozzle determines the size of the fan spray and the pressure out of the nozzle.

0° Nozzel-Red: This nozzle delivers a pinpoint stream of pressurized water and is extremely powerful. It covers only a small area of cleaning. This nozzle should only be directed at surfaces that can withstand high pressure such as metal or concrete. Do not use this nozzle to clean wood.

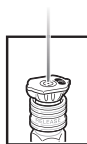

15° Nozzel-Yellow: This nozzle delivers a powerful 15 degree spray pattern for intense cleaning of small areas. This nozzle should only be used on areas and materials that can withstand high pressure.



25° Nozzel-Green: This nozzle delivers a 25 degree spray pattern for intense cleaning of larger areas. It should only be used on areas that can withstand pressure from this nozzle.



40° Nozzel-White: This nozzle delivers a 40 degree spray pattern and a less powerful stream of water. This nozzle can cover a wide area and should be used for most general cleaning jobs.



Chemical Nozzel-Black: This nozzle is used to apply special chemicals and cleaning solutions. This nozzle produces the weakest pressure stream of the three nozzles.

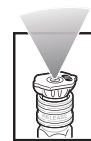

2. Nozzles To Spray Wand

⚠ WARNING

Never place hands in front of nozzle. Never grasp hose or fittings during Pressure Washer operation.

Never attempt to attach or remove spray wand or hose fittings while Pressure Washer system is pressurized. Turn off Pressure Washer and lock the Gun Trigger before attempting to change pressure nozzles.

2.1 To attach, insert nozzle into female quick-disconnect spray wand and press to snap in the nozzle.

2.2 To detach, slide down slip ring on female quick-disconnect to eject the nozzle.

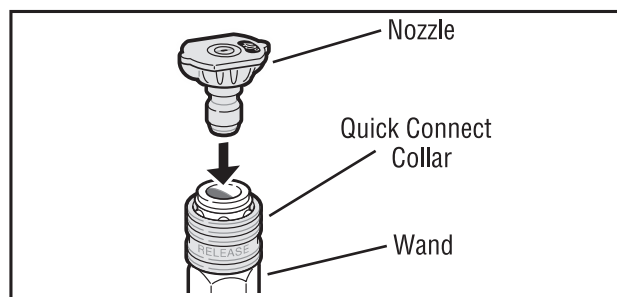

3. Using The Spray Gun

⚠ WARNING

To prevent accidental discharge of high pressure washer, the trigger lock on the trigger should be engaged whenever the pressure washer is not in use.

To disengage the trigger Lock, push the lock down and into its original position.

To Operate The Trigger:

3.1 Squeeze the trigger to start water flow through the nozzle.

3.2 Release the trigger to stop water flow.

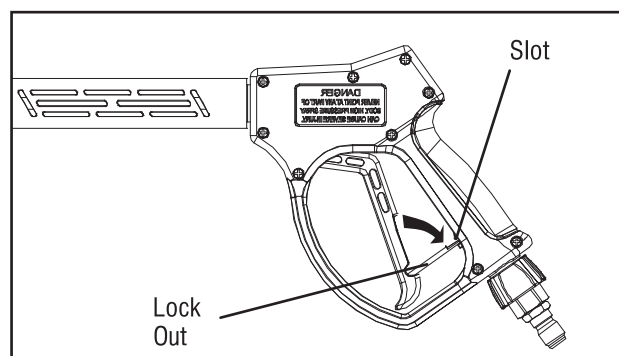

OPERATION

4. Washing/Cleaning

WARNING

SOME ENGINE PARTS CAN BECOME EXTREMELY HOT.

Do not allow the pressure hose come in contact with engine exhaust system which can cause damage to the hose.

Damaged hoses can burst and can cause injection injuries.

- 4.1 Firmly grip spray gun with both hands.
- 4.2 Start with a low pressure Nozzle, and gradually use higher pressures as needed. Test spray the edge of the surface to be cleaned first to make sure that the stream is not too strong for the surface, If the stream damages the surface, move further away from the surface being cleaned to reduce the pressure being applied to the surface. If the stream is still too strong, lock the Trigger in the safety position and change to a lower pressure Nozzle.
- 4.3 Point the nozzle to a safe direction and squeeze the spray gun trigger to allow the pump to purge air and impurities in the system and then redirect the nozzle to the working surface.
- 4.4 Clean vertical and sloped surfaces from the top down.
- 4.5 When cleaning horizontal surfaces, occasionally use the stream to clear the area of excess water.
 - For most effective cleaning, keep spray nozzle from 8 to 24 inches away from cleaning surface.
 - If you get spray nozzle too close, you may damage surface being cleaned.
 - DO NOT get closer than 6 inches when cleaning tires.

5. Pressure Adjustment

Increase distance: To vary the pressure on the surface being cleaned, vary the distance between spray wand and the surface being cleaned.

Change pressure wand nozzle: Completely shut down Pressure Washer and stop petrol engine.

Change spray nozzle for desired pressure (see "Selecting The Right Nozzle" on Page 13). Restart engine.

6. Using Chemicals And Cleaning Solvents

NOTICE :

Use only soaps and chemicals designed for use with pressure Washer. DO NOT USE CHLORINE BLEACH. Chemicals pressure nozzle is used. Only use the Black (low pressure) Nozzle when spraying detergents. Fill Detergent Tank (NOT supplied) with pressure Washer will draw one litre of detergent for every seven litres of water.

- 1 If the Pressure Washer have a onboard soap tank:
 - 1.1 Fill the soap tank with detergent and close the lid.
 - 1.2 Change the nozzle in the wand to Black Nozzle.
 - 1.3 Start the engine.

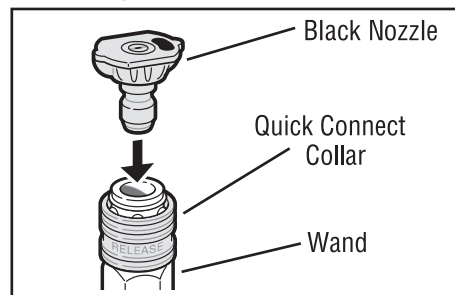

- 2 If the Pressure Washer doesn't have a soap tank:
 - 1.1 Connect the Siphon Tube with Strainer to the brass barb on the high pressure hose connection area of the pump.
 - 1.2 Submerge the strainer end of the siphon tube in the soap/detergent solution bottle or bucket.
 - 1.3 Change the nozzle to black nozzle and start engine.

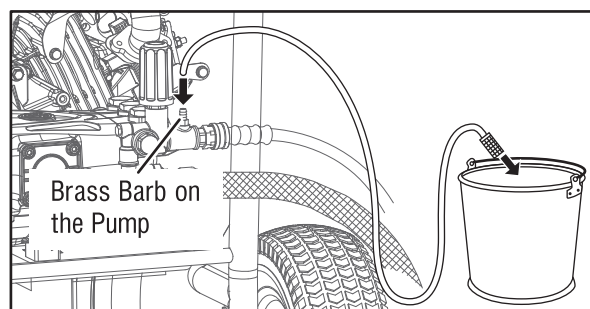

7. To Rinse

- 7.1 Replace the nozzle with an appropriate high pressure nozzle (see "Selecting The Right Nozzle" on Page 13). Squeeze the trigger and wait for the detergent to clear.
- 7.2 Keep the spray gun a safe distance from the area you plan to spray.
- 7.3 Apply a high pressure spray to a small area, and then check the surface for damage, If no damage is found, it is okay to continue cleaning.
- 7.4 Start at the top of the area to be rinsed, working down with same overlapping strokes as you used for washing and applying detergent.

8. Cleaning Tips

WARNING

Never use the Pressure Washer water inlet to siphon detergent or wax.

Leaving chemicals and cleaning solutions inside the pressure pump could damage it. Damages created by leaving soaps, chemicals and cleaning solutions inside the pump can void the warranty.

OPERATION

Stopping the Engine and Pressure Washer

WARNING

SOME ENGINE PARTS CAN BECOME EXTREMELY HOT. If you intend to disconnect the high pressure hose after completing a wash, avoid touching the engine exhaust system while disconnecting the high pressure hose from the pump

1. To stop the engine in an emergency, turn the Engine Switch off.

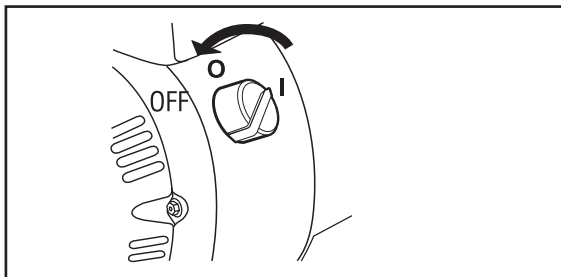

2. Under normal conditions, use the following procedure:
 - 2.1 Release the Trigger on the Spray Gun handle.
 - 2.2 Turn the Engine Switch off.
 - 2.3 Close the Fuel Valve.
 - 2.4 Turn the water supply off.

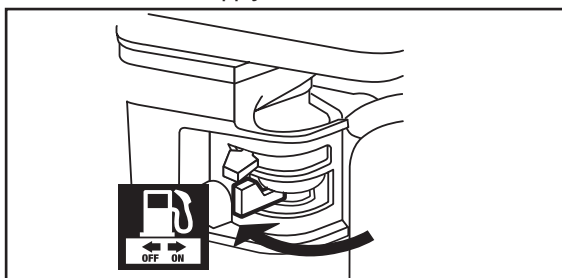

3. Squeeze the Trigger to release excess pressure.
4. If pressure washer detergent has been used, run clean water through the system to eliminate detergent residue using the following procedure:
 - 4.1 Turn off the Engine as detailed in step 2.
 - 4.2 Fill the Detergent Tank (Not supplied) with clean water.
 - 4.3 Remove the Nozzle and restart the Engine (Following directions in "Starting The Engine" on page 11.)
 - 4.4 Point Wand in safe direction and hold down to flush water through system until clean.
 - 4.5 Turn off the Engine as detailed in step 2.

High Altitude Operation

At high altitudes over 3,000 feet, the engine carburetor and any other parts that control the fuel-air ratio will be affected, which will decrease performance, increase fuel consumption and increase emission. Proper operation can be ensured by installing an altitude kit by a qualified mechanic when use at altitude higher than 3,000 feet. Refer to the altitude kit and operation instruction (provided) when needed.

MAINTENANCE

WARNING

Regular maintenance will improve performance and extend life of Pressure Washer. Pressure Washer's warranty does not cover items that have been subjected to operator abuse or negligence. Only by maintaining Pressure Washer in accordance with instructions in this manual will the full value of the warranty be honored. Some adjustments will need to be made periodically to properly maintain the Pressure Washer. All service and adjustments should be made at least one time each season. It is important that the maintenance chart below be followed.



Many maintenance procedures, including any not detailed in this manual, will need to be performed by a qualified technician for safety. If you have any doubts about your ability to safely service the equipment or engine, have a qualified technician service the equipment instead.

Engine Maintenance Schedule

NOTICE :

This maintenance schedule is intended solely as a general guide. If performance decreases or if equipment operates unusually, check systems immediately. The maintenance needs of each piece of equipment will differ depending on factors such as duty cycle, temperature, air quality, fuel quality, and other factors.

NOTICE :

The following procedures are in addition to the regular checks and maintenance explained as part of the regular operation of the engine and equipment.

Frequency	Items	Each Time	Every month or 20 Hrs	Every 3 months or 50 Hrs	Every 6 months or 100 Hrs	Every Year or 300 Hrs	
Brush off outside of engine							
Engine Oil	Check oil level	√					
	Replace				√ *		
Air Filter	Check	√					
	Clean			√	√ *		
	Replace					√ *	
Deposit Cup	Clean				√		
Spark Plug	Clean, Adjust				√ ***		
	Replace					√ *	
Spark Arrster	Clean				√		
Valve Clearance	Clean, Adjust					√ **	
Fuel Tank	Clean					√ **	
Emission & Evaporation System						√ **	
Fuel Supply Line	Clean	Every two years (Replace if necessary**)					

- * Recommended to be performed more often than in the schedule if operated in dusty environments.
- ** Recommended to be performed by qualified technician.
- *** Adjust air gap to 0.6mm - 0.7mm.

MAINTENANCE

Pump Maintenance

- Before doing any maintenance work, depressurise the water system and isolate the pump from all energy sources.
- When the jobs are done, before restarting the pump, check that no tools, rags or other materials have been left close to moving parts or in hazardous zones.
- Replace any excessively worn components with original parts and use lubricants recommended by manufacturer.
- Carry out the routine maintenance procedures specified by the manufacturer to keep pump safe and performing well.

Scheduled service table			
Frequency	Component	Procedure	Reference
Every working day	Filter	Inspect filter cartridge	See "Inspecting the filter"
	Pump Pump	Oil level check	See "Checking the oil level"
Every 50 working hours	Connection to engine	Inspection visually	
	Pump Pipes and connections	Inspect mounting	See "Inspecting the pump mounting"
	Pipes and connections	Inspection	See "Inspecting the connections and pipes"
	Pump	Oil change (1)	See "Change the oil"
Every 500 working hours or every year	Pump	Oil change	See "Change the oil"
Every 1000 working hours	Pump gaskets	Replacement	Contact an authorised service centre
	Valves	Replacement	Contact an authorised service centre

(1) This interval refers to the first oil change only

Checking pump oil level

- Check the oil with the pump level and cold.
- Check the amount of oil through the level gauge(A).
- If necessary, top up with oil with the characteristics specified in the "Comparison table of lubricants"
- To top up with oil proceed as described below. Unscrew the plug (B) and pour oil in until it is halfway up the level gauge (A), screw on the plug (B).

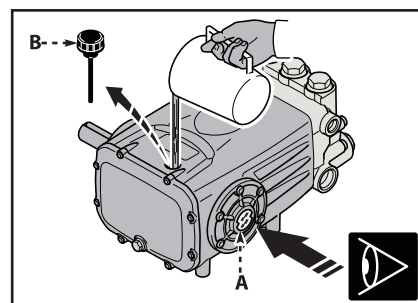

Changing pump oil

Position machine in which the pump is incorporated perfectly level, with the pump slightly warm. Do not release oil into the environment. Dispose of spent oil in accordance with statutory requirements. To change oil, proceed as described below:

- Position a receptacle of suitable capacity to collect the spent oil.
- Unscrew the drain plug (A) and allow all the oil to flow out, screw on the drain plug (A).
- Unscrew the fill plug (B), pour in the fresh oil through the filler hole until the correct level is reached (see "Checking the oil level") screw on the filler plug (B).

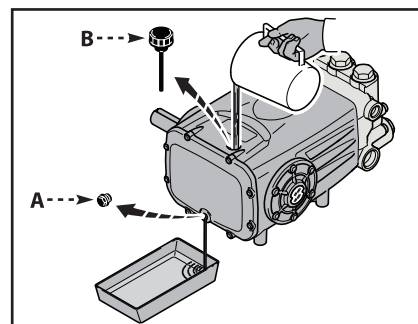

MAINTENANCE

Pump Maintenance (Continued)

1. Checking Pressure Pump

The pressure pump is maintenance free. If you notice any sign of oil leakage in and around the pump, DO NOT operate the pressure washer.

2. Cleaning Nozzle

Ocasionaly, the spray wand can become clogged with foreign materials such as dirt. When this happens excessive pressure can develop. When ever the pressure nozzle becomes partially clogged, the pump pressure will pulsate. It should be immediately cleaned.

2.1 Make sure Pressure Washer is shut off and spray gun trigger is locked.

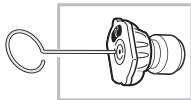

2.2 Remove high pressure spray nozzle from spray wand. Using the nozzle cleaning needle (provided), remove any obstructions by inserting and carefully moving the pin back-and-forth through nozzle hole under clean running water.

2.3 After cleaning, remove the needle from nozzle and store for future use.

2.4 Reassemble pressure nozzle to spray wand.

3. Cleaning Water Inlet Screen Filter

The water inler screen filter shoule be checked periodically and cleaned if necessary.

3.1 Disconnect inlet water hose.

3.2 Remove filter by grasping end and pull straight back.

3.3 Clean screen filter by flushing both sides with water.

3.4 Insert screen filter back inside water inlet port.

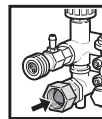

WARNING

DO not operate Pressure Washer without screen filter. Impurities entering pressure pump can cause internal damage.

Cleaning Pressure Washer

Daily or before use inspections should include areas around and underneath Pressure Washer looking for signs of fuel or oil leaks. Preventative maintenance should be taken if leakage is found. Clean accumulated debris from outside and inside Pressure Washer. Ensure all linkages, springs and other engine controls are kept clean. Inspect cooling air slots and openings on Pressure Washer. Openings must be kept clean and unobstructed for peak performance of Pressure Washer. Engine components should be kept clean reducing risk of overheating and ignition of accumulated debris.

- Use a damp cloth to wipe exterior surfaces clean.
- Use a soft bristle brush to loosen caked on dirt or oil.
- Use a shop-vacuum to pick up any loose dirt and debris.

Changing Engine Oil

▲CAUTION

Oil is very hot during operation and can cause burns. Wait for engine to cool before changing oil.

1. Make sure the engine is stopped and is level.
2. Close the fuel Valve.
3. Place a drain pan (not included) underneath the crankcase's drain plug.
4. Remove the drain plug and if possible, tilt the crankcase slightly to help drain the oil out. Recycle used oil.
5. Replace the drain plug and tighten it.
6. Clean the top of the Dipstick and the area around it. Remove the Dipstick by turning it counterclockwise, and wipe it off with a clean, lint free rag.

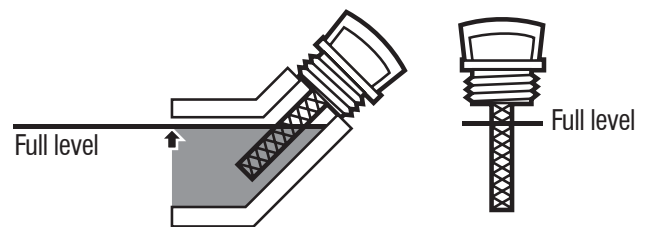

Adding Engine Oil

All oil should meet minimum American Petroleum Institute (API) Service Class SJ, SL or better. Use no special additives. Select the oil's Viscosity grade according to the expected operating temperature (also see chart).

The SAE Viscosity Grade Chart

Above 40° F, use 10W-30

Between 40° F and 10° F, use 10W-30

Below 10° F, use synthec 5W-30

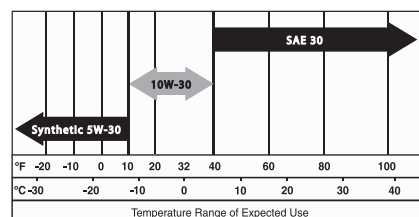

Replace the Dipstick and Clockwise.

NOTICE :

Do not run the engine with too little oil. Engine will not start with low or no engine oil.

MAINTENANCE

Spark Plug Maintenance

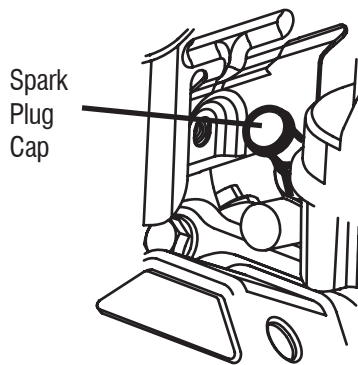

1. Disconnect spark plug cap from end of plug. Clean out debris from around spark plug.
2. Using a Spark plug wrench, remove the spark plug.
3. Inspect the spark plug:

If the electrode is oily, clean it using a clean, dry rag. If the electrode has deposits on it, polish it using emery paper. If the white insulator is cracked or chipped, the spark plug needs to be replaced.

Recommended Spark Plugs	
NGK®	BP-6ES
NHSP® / TORCH®	F6TC

NOTICE:

Using an incorrect spark plug may damage the engine.

4. When installing a new spark plug, adjust the plug's gap to the specification on the Specifications chart. Do not pry against the electrode, the spark plug can be damaged.
5. Install the new spark plug of the cleaned spark plug into the engine.
 - Gasket-style
Finger-tighten until the gasket contacts the cylinder head, then tighten about 1/2-2/3 turn more.
 - Non-gasket-style
Finger-tighten until the plug contacts the cylinder head, then tighten about 1/16 turn more.

NOTICE:

Tighten the spark plug properly. If loose, the spark plug will cause the engine to overheat. If overtightened, the threads in the engine block will be damaged.

6. Apply dielectric spark plug boot protector (not included) to the end of the spark plug and reattach the wire securely.

Air Filter Maintenance

1. Remove the Air Filter Cover and the air filter(s) and check for dirt. Clean as described below.
2. Cleaning:
 - For paper filters:
To prevent injury from dust and debris, wear ANSI-approved NIOSH-approved dust mask/respirator, and heavy-duty work gloves. In a well-ventilated area away from bystanders, use pressurized air to blow dust out of the filter. If this does not get the filter clean, replace it.
 - For foam filters:
Wash the filter in warm water and mild detergent several times. Rinse. Squeeze out excess water and allow it to dry completely. Soak the filter in lightweight oil briefly, then squeeze out the excess oil.
3. Install the cleaned filter(s). Secure the Air Filter Cover before use.

Long-term Storage

When the equipment is to remain idle for longer than 20 days, prepare the Engine for storage as follows:

1. Cleaning

Wait for Engine to cool, then clean Engine with dry cloth.

NOTICE:

Do not clean using water. The water will gradually enter the Engine and cause rust damage. Apply a thin coat of rust preventive oil to all metal parts.

2. Fuel

Petrol fuel can become stale when stored over 30 days, which will cause acid and gum deposits to form in the fuel system or crucial carburetor parts. To keep fuel fresh, add fuel stabilizer tablets to the fuel tank. Draining petrol is unnecessary if the fuel stabilizer is used according to the instructions that come with it. Run Pressure Washer engine for a minimum of two minutes, after stabilizer is added to fuel, to allow it to circulate throughout the engine. The engine and fuel can be stored up to 24 months.

⚠ WARNING



TO PREVENT SERIOUS INJURY FROM FIRE:
Fill tank in a well-ventilated area away from ignition sources. If the engine is hot from use, shut the engine off and wait for it to cool before adding fuel. Do not smoke.

MAINTENANCE

3. Lubrication

To protect against rust formation during storage, oil the cylinder bore:

- 3.1 Change engine oil.
- 3.2 Clean out area around spark plug. Remove spark plug and pour approximately 1/2 oz (15 ml) of clean engine oil into cylinder through spark.
- 3.3 Replace spark plug, but leave spark cap disconnected.
- 3.4 Pull Starter Handle to distribute oil in cylinder. Stop after one two revolutions when you feel piston start the compression stroke (when you start to feel resistance.)

WARNING

Unintentional sparking can cause fire or electrical shock. Failure to observe this warning can cause severe property damage, severe burns and even death. Disconnect spark plug wire from spark plug and cover tip of spark plug wire with insulating tape and place wire where it cannot come in contact with spark plug or Pressure Washer frame.

4. Storing Accessories

The Pressure Washer is equipped with places to store your accessories as shown.

- 4.1 Place Spray Gun into Gun Holder.
- 4.2 Place nozzles on the nozzle panel.
- 4.3 Coil and tie Pressure Hose, and hang on the hose hanger.

5. Pump Preparation:

- 5.1 Disconnect the Pressure Hose and water supply hose from the Pump.
- 5.2 Connect a short length of garden hose with a male hose connector on one end to the Pump's water inlet connection.
- 5.3 Use a funnel to add approximately 170 mL of RV antifreeze to the Pump.

NOTICE :

Use only RV antifreeze. Other types of antifreeze are corrosive and can damage Pump.

- 5.4 With spark plug cap disconnected and Engine switch in OFF position, pull Starter Handle several times until antifreeze begins to come out of Pump outlet fitting.
- 5.5 Remove Pressure Hose from Pump.

6. Storage Area

Cover and store in a dry, level, well-ventilated area out of reach of children. Storage area should also be away from ignition sources, such as water heaters, clothes dryers and furnaces.

7. Every 3 Months, To Protect Engine and Warranty Coverage

- 7.1 Safely drain antifreeze, and dispose of properly.
- 7.2 Connect Pressure Hose and water supply hose.
- 7.3 Turn on water supply, remove nozzle, point wand in safe direction, and hold down trigger until all air is released from the system, at least 30 seconds. Then release the Trigger, lock it in the safety position and replace Nozzle before starting engine.
- 7.4 Discharge nozzle in safe direction run engine for 15-20 minutes or the Warranty is VOID. Turn off engine.
- 7.5 Discharge nozzle in safe direction, and then disconnect hoses and drain water.
- 7.6 Connect a short length of garden hose with a male hose connector on one end to the Pump's water inlet connection.
- 7.7 Use a funnel to add approximately 170 mL of RV antifreeze to the Pump.

NOTICE :

Use only RV antifreeze. Other types of antifreeze are corrosive and can damage Pump.

8. Preparation For Use After Storage

- 8.1 Slowly pull the starter cord a few times to clean oil from the cylinder or to eject any antifreeze from the pump which were added prior to storage.
- 8.2 Remove the spark plug from the cylinder. Wipe oil from the spark plug and return it to the cylinder and retighten.
- 8.3 Reconnect the spark plug wire.

MAINTENANCE

Trouble Shooting

Problem	Possible Causes	Probable Solutions
Engine will not start	FUEL RELATED: 1.No fuel in tank of fuel valve is in "OFF" position. 2.Low quality, stale, dirty or deteriorated petrol. 3.Choke not in START position, cold engine. 4.Carburetor not primed. 5.Dirty fuel passageways. 6.Carburetor needle stuck. Fuel can be smelled in the air. 7.Too much fuel in chamber, This can be caused by the carburetor needle sticking. 8.Intake valve stuck open or closed. 9.Clogged Fuel Filter.	FUEL RELATED: 1.Fill fuel tank with fresh 87+ octance unleaded stabilizer-treated gasoline and turn fuel valve to "ON" position. Do not use gasoline with more than 10% ethanol (E15, E20, E85, etc.). 2.Drain fuel tank and carburetor;fill with fresh fuel. 3.Move Choke to START position. 4.Pull on Starter Handle to prime. 5.Clean out passageways using fuel additive. Heavy deposits may require further cleaning. 6.Gently tap side of carburetor float chamber with screwdriver handle. 7.Turn Choke to RUN position. Remove spark plug and pull the start handle several times to ait out the chamber. Reinstall spark plug and Choke to START position. 8.Replace Fuel Filter.
	IGNITION(SPARK) RELATED: 1.Spark plug cap not connected securely. 2.Spark plug electrode wet or dirty. 3.Incorrect spark plug cap. 4.Sparkplug cap broken. 5.Incorrect spark timing or faulty ignition system.	IGNITION(SPARK) RELATED: 1.Connect spark plug cap properly. 2.Clean spark plug. 3.Correct spark plug cap. 4.Replace spark plug cap. 5.Have qualified technician diagnose/repair ignition system.
	COMPRESSION RELATED: 1.Cylinder not lubricated. Problem after long storage periods. 2.Loose or broken spark plug.(Hissing noise will occur when trying to start.) 3.Loose cylinder head or damaged head gasket. (Hissing noise will occur when trying to start.) 4.Engine valves or tappets mis-adjusted or stuck.	COMPRESSION RELATED: 1.Pour tablespoon of oil into spark plug hole. Crank engine a few times and try to start again. 2.Tighten spark piug. If that does not work, replace spark plug. If problem persists, may have hesd gasket problem see#3. 3.Tighten head. If that does not remedy problem,replace headgasket. 4.Have qualified technician adjust/repair valves and tappets.
	ENGINE OIL RELATED: 1.Low engine oil. 2.Engine mounted on slope, triggering low oil shutdown.	ENGINE OIL RELATED: 1.Fill engine oil to proper level. Check engine oil before EVERY use. 2.Operate engine on level surface. Check engine oil level.
Engine "hunts" or falters	1.Carburetor is running too rich or too lean. 2.Clogged or dirty fuel filter.	1.Clean or replace fuel filter.
Engine lacks power	1.Cylinder pressure is low. 2.Dirty air filter.	1.Clean or replace fuel filter.

MAINTENANCE

Trouble Shooting(Continued)

Problem	Possible Causes	Probable Solutions
Engine misfires	<ol style="list-style-type: none"> 1. Sparkplug cap loose. 2. Incorrect or defective spark plug. 3. Defective spark plug cap. 4. Old or low quality gasoline 5. Incorrect compression. 	<ol style="list-style-type: none"> 1. Check wire connections. 2. Re-gap or replace spark plug. 3. Replace spark plug cap. 4. Use only fresh 87 + octane stabilizer-treated unleaded gasoline. Do not use gasoline with more than 10% ethanol (E15, E20, E85, etc.). 5. Diagnose and repair compression. (See Engine will not start: COMPRESSION RELATED section.)
Engine stops suddenly	<ol style="list-style-type: none"> 1. Fuel tank empty or full of impure or low quality gasoline. 2. Low oil shutdown. 3. Defective fuel tank cap creating vacuum, preventing proper fuel flow. 4. Faulty magneto. 5. Disconnected or improperly connected spark plug cap. 	<ol style="list-style-type: none"> 1. Fill fuel tank with fresh 87 + octane stabilizer-treated unleaded gasoline. Do not use gasoline with more than 10% ethanol (E15, E20, E85, etc.) 2. Fill engine oil to proper level. Check engine oil before EVERY use. 3. Test/replace fuel tank cap. 4. Have qualified technician service magneto. 5. Secure spark plug cap.
Engine stops when under heavy load	<ol style="list-style-type: none"> 1. Dirty air filter 2. Engine running cold. 	<ol style="list-style-type: none"> 1. Clean or replace element. 2. Allow engine to warm up prior to operating equipment.
Engine knocks	<ol style="list-style-type: none"> 1. Old or low quality gasoline. 2. Engine overloaded. 3. Incorrect spark timing, deposit buildup, worn engine, or other mechanical problems. 	<ol style="list-style-type: none"> 1. Fill fuel tank with fresh 87 + octane stabilizer-treated unleaded gasoline. Do not use gasoline with more than 10% ethanol (E15, E20, E85, etc.) 2. Do not exceed equipment's load rating. 3. Have qualified technician diagnose and service engine.
Engine backfires	<ol style="list-style-type: none"> 1. Impure or low quality gasoline. 2. Engine too cold. 3. Intake valve stuck or overheated engine. 4. Incorrect timing. 	<ol style="list-style-type: none"> 1. Fill fuel tank with fresh 87 + octane stabilizer-treated unleaded gasoline. Do not use gasoline with more than 10% ethanol (E15, E20, E85, etc.) 2. Use cold weather fuel and oil additives to prevent backfiring. 3. Have qualified technician diagnose and service engine. 4. Check engine timing.
No pressure or Low pressure	<ol style="list-style-type: none"> 1. Spray wand not set high pressure. 2. Inadequate water supply. 3. Hose fitting leaks during high pressure. 4. Nozzle obstructed. 5. Water filter screen obstructed. 6. Defective pump. 7. Air in hose. 8. Choke lever in "CHOKE" position. 	<ol style="list-style-type: none"> 1. See "Selecting The Right Nozzle" on Page 13. 2. Water supply must be 5 GPM @ 20 PSI. 3. Tighten hose fitting. Use thread sealant tape if necessary. 4. Clean Nozzle (See "Cleaning Nozzle" on Page 16). 5. Remove and clean filter. 6. Squeeze trigger to remove air. 7. Move choke to "RUN" position.

MAINTENANCE

Trouble Shooting(Continued)

Problem	Possible Causes	Probable Solutions
Output pressure varies	<ol style="list-style-type: none"> 1. Not enough water supply. 2. Water inlet screen is clogged. 3. Nozzle is clogged. 4. Nozzle has mineral build up. 	<ol style="list-style-type: none"> 1. Check water supply hose for kinks, leaks, or blockage. Open faucet all the way. 2. Remove inlet screen and rinse out. 3. Remove Nozzle and clean. 4. Remove Nozzle and clean with vinegar.
Water or Oil Leaking at Pump	<ol style="list-style-type: none"> 1. Loose connections. 2. Worn or broken O-rings. 3. Pump head or tubes damaged from freezing. 	<ol style="list-style-type: none"> 1. Tighten connections.
No intake of detergent	<ol style="list-style-type: none"> 1. Detergent hose not properly inserted into unit. 2. Tube cracked or split. 3. Wrong Nozzle. 4. Injector turned off. 5. Injection tube strainer clogged. 6. Nozzle blocked. 7. Dried detergent in injector. 	<ol style="list-style-type: none"> 1. Push firmly into injector. 2. Replace tube. 3. Switch to Black Nozzle. 4. Turn collar counterclockwise. 5. Clean strainer. 6. Clean Nozzle. 7. Dissolve by running warm water through the injection tube. Run clean water through injector until clear.
Water leaking at spray gun/wand connection	<ol style="list-style-type: none"> 1. Worn or broken O-ring. 2. Loose hose connection. 	<ol style="list-style-type: none"> 1. Tighten hose connection.

PARTS LIST AND DIAGRAM

General Assembly Diagram

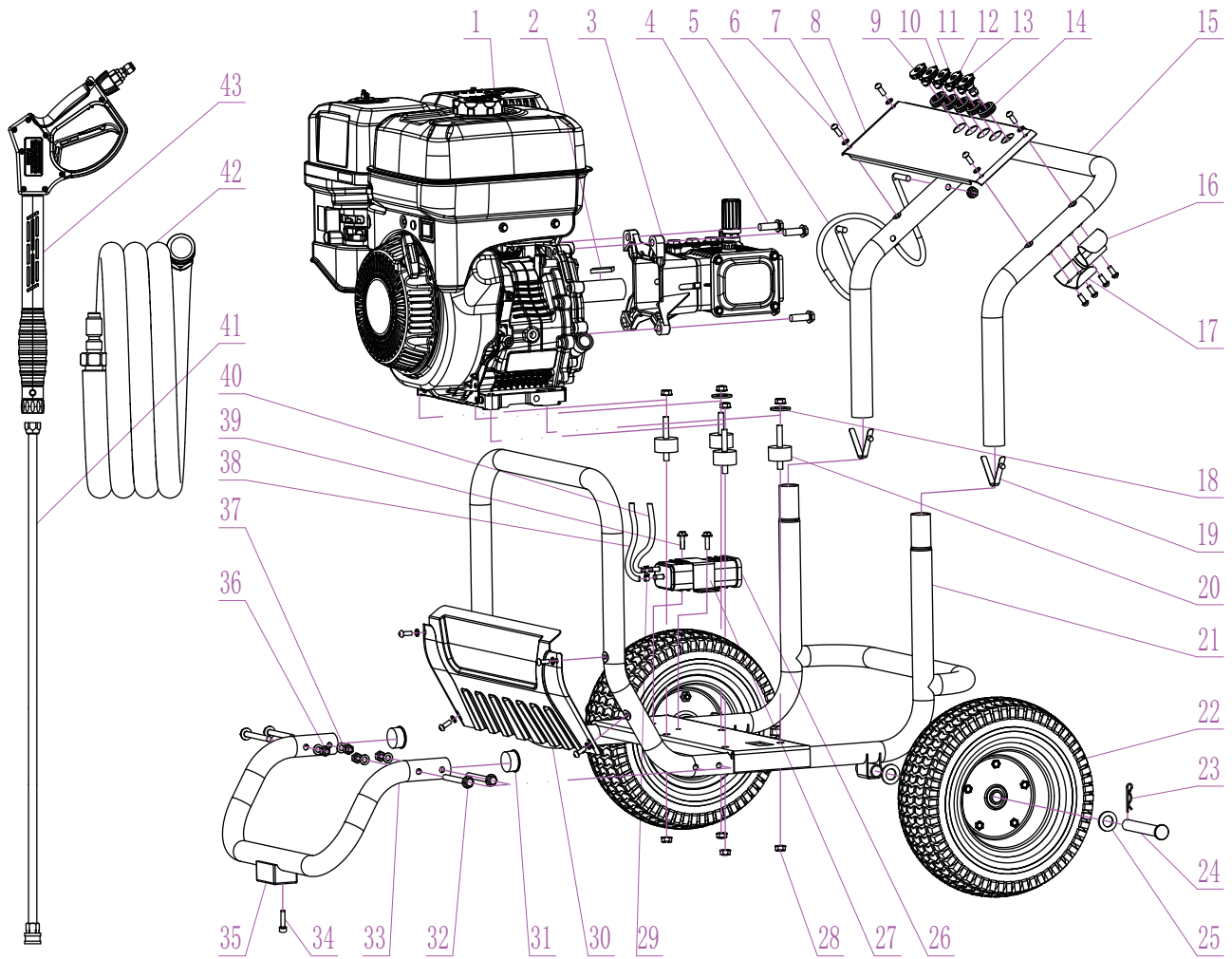

PARTS LIST AND DIAGRAM

General Parts List

PART	DESCRIPTION	QTY
1	Engine	1
2	Key	1
3	Pump	1
4	Hex bolts	4
5	High Pressure Hose Hook	1
6	Hex Bolts	12
7	Flat Washer	8
8	Nozzle Panel	1
9	Nozzle 0°	1
10	Nozzle 15°	1
11	Nozzle 25°	1
12	Nozzle 40°	1
13	Nozzle POM	1
14	Nozzle Holder	5
15	Handle Assy	1
16	Hook	1
17	Hook	1
18	Flat Washer	2
19	V-shaped Buckle	2
20	Shock Absorbing Mount	4
21	Frame	1
22	Wheel	2
23	Pin Lock Clamp	2

PART	DESCRIPTION	QTY
24	Axle	2
25	Flat Washer	4
26	Carbon Tank	1
27	Carbon Tank Base Plate	1
28	Hex Nut	9
29	Clamp	5
30	Front Damper	1
31	Rubber Plug	2
32	Hex Bolts	4
33	Handle Assy	1
34	Rubber Shock Absorbing Mount	1
35	Hex Bolts	1
36	Locknut	4
37	Flat Washer	4
38	Fuel Pipe	0.34m
39	Hex Bolts	2
40	Fuel Pipe	0.52m
41	Wand	1
42	High Pressure Hose	1
43	Spray Gun	1

SPECIFICATIONS

Pressure specifications

Pressure	4400PSI
Flow	15L/min
Displacement	459cc
Fuel Capacity	6.5L
Low Oil Sensor	YES
Thermal Relief Valve	YES

WARRANTY

WARRANTY CONDITIONS

Thank you for purchasing a quality Maxwatt Power product.

Subject to the exclusions set out below.

Maxwatt Power Products PTY Ltd (the "Company") warrants that that this product will be free from defects in materials or workmanship for (2) years from the date of original sale (hereinafter the "Warranty Period") in normal domestic applications such as personal, residential household or recreational use from the date of purchase.

A Warranty Period of (1) year shall apply in commercial applications such as income producing, rental or other business-related use. Goods sold to a Consumer with an Australian Business Number shall be deemed as being used in a commercial application.

The Warranty Period is continuous from the date of original sale and does not restart upon the repair or replacement of the Goods or any part thereof.

The benefits conferred by this warranty are in addition to all rights and remedies which you may be entitled to under the Australian Consumer Law and any other statutory rights you may have under other applicable laws. This warranty does not exclude, restrict, or modify any such rights or remedies.

LIMITED WARRANTY

"This is a "walk in" warranty policy and is limited to the range of generators specified herein". We recommend that you take the generator to the nearest service agent for assistance. Please visit www.maxwatt.com.au for more information. Upon return – transportation charges shall be borne and prepaid by the Consumer – to the Company's or its nominated dealer's premises within the Warranty Period, the Company shall repair or replace, at its option, any Goods which it determines to contain defective material or workmanship and shall return said Goods to the Consumer free-on-board at the Company's or agent's premises. The repair or replacement work will be scheduled and performed according to the Company's normal workflow and availability of replacement parts.

The Company shall not be obligated, however, to repair or replace Goods which have been repaired by others; abused; improperly installed, operated, maintained, repaired, transported, or stored; not serviced to schedule using genuine spare parts; altered or otherwise misused or damaged in any way. This warranty does not apply where a defect or other issue with the product is caused by normal wear and tear, misuse, or abuse of this product.

WHAT THE APPOINTED SERVICE AGENT WILL REPAIR OR REPLACE UNDER WARRANTY:

"The appointed Service Agent will repair or replace, at its sole discretion, any part that is proven to be defective in material or workmanship under normal use during the applicable warranty time period. Warranty repairs will be made without any charge for parts and labour.

All parts replaced will be considered as part of the original product and the warranty on such parts will expire coincident with the original product warranty.

WARRANTY

EXCLUSIONS TO THIS LIMITED WARRANTY INCLUDE:

Neglect in the periodic maintenance as specified in the owner's manual.

Improper repairs or maintenance including any repairs and or maintenance carried out by a non-accredited service agent.

Operating methods other than those indicated in the owner's manual.

The use of non-genuine parts and or accessories other than those supplied by an accredited service agent.

Normal wear and tear including but not limited to the fading of painted or plated surfaces.

Consumable parts including but not limited to spark plugs, fuel and oil filters, recoil starter ropes, wheels, lubricants, oil, grease, and fuel.

Cleaning adjustments and normal periodic maintenance work including but not limited to cleaning the carburetor, engine oil, fuel tank and injectors.

Correct preparation when using the pressure washer for the first time as set out in the owner's manual.

Damage because of but not limited to incorrect use, incorrect re-fueling and any other causes as set out in the owner's manual.

DISCLAIMER OF IMPLIED WARRANTIES

Maxwatt Power Products disclaims any responsibility for the loss of time or use of the product, transportation, commercial loss or any other incidental or consequential loss or damage. Any implied warranties are limited to the duration of this written limited warranty policy and procedures manual.

Proof of Purchase

It is recommended that you keep a copy of the original tax invoice for your records.

Warrantor

Name: Maxwatt Power Products Pty Ltd

Address: Unit 15/16 1440 New Cleveland Road Chandler 4155





Phone: 0737325363

Email: customercare@maxwatt.com.au



Web: www.maxwatt.com.au

WARRANTY

Please Note the Following Terms & Conditions.

-  — Customer is required to return the pressure washer to the store.
-  — The pressure washer will be repaired at no charge to the customer should the fault be deemed a manufacturer defect only.
-  — The approximate lead time for repairs is **14 - 21 working days** from the time the pressure washer is received at the Maxwatt Service Center.
-  — A copy of the proof of purchase is required when returning the pressure washer for repairs. The warranty is null and void without a copy of proof of purchase.

NOTE: THE FOLLOWING IS EXCLUDED FROM THE MANUFACTURER WARRANTY POLICY.

-   — Neglect in the periodic maintenance as specified in the owners / operator's manual.
-   — Improper repairs or maintenance carried out.
-   — Operating methods other than those indicated in the owner / operator's manual.
-   — Normal "wear & tear" due to day-to-day use & operation.
-   —  Spark Plug  Oil  Fuel & Oil Filters  Recoil Starter Rope  Wheels  Fuel

WARRANTY



CHECK LIST PRIOR TO SENDING THE PRESSURE WASHER IN FOR ASSESSMENT / REPAIR.



Ensure that there is the correct amount of oil and that it does not need to be replaced.



Ensure that there is sufficient fuel.



Ensure that the spark plug does not need to be cleaned or replaced.



Ensure that the pressure washer **has been serviced** if it has run for more than 50 hours. Check the owners / operator's manual for information.



Distributed by: Maxwatt Power Products
Unit 15/16 , 1440 New Cleveland Road, Chandler Queensland Australia