

MAXWATT®

POWER WHEN YOU NEED IT

OWNER'S MANUAL & OPERATION INSTRUCTION

MX13000iS



PORTABLE INVERTER GENERATOR

SAVE THIS MANUAL: This manual contains important information regarding safety, operation, maintenance, and storage of this product. Before use, read carefully and understand all cautions, warnings, instructions, and product labels. Failure to do so could result in serious personal injury and/or property damage.

Congratulations on your selection of this generator. We are certain you will be pleased with your purchase of one of the finest generators on the market.

We want to help you get the best results from your new generator and to operate it safely. This manual contains the information on how to do that, please read it carefully.

When your generator needs scheduled maintenance, keep in mind that your servicing dealer is specially trained in servicing generators and is supported by the parts and service divisions. Your servicing dealer is dedicated to your satisfaction and will be pleased to answer your questions and concerns.

Model:	MX13000iS
Starting Watts:	13000 W
Running Watts:	12000 W
Ac Voltage:	240 V
Amperage:	50 A
Frequency:	50 Hz
Phase:	Single
Power Factor:	1.0
RPM:	3400
Fuel capacity:	40L
Engine:	SV750(744cc)
Engine Oil:	1.5L

CONTENTS

IMPORTANT SAFETY INSTRUCTIONS	3
SYMBOLS	12
ELECTRICAL	13
FEATURES	15
ASSEMBLY	19
OPERATION	20
MAINTENANCE	28
TROUBLESHOOTING	35
WARRANTY INFORMATION	36

IMPORTANT SAFETY INSTRUCTIONS



DANGER:

Carbon Monoxide. Using a generator indoors CAN KILL YOU IN MINUTES. Generator exhaust contains high levels of carbon monoxide (CO), a poisonous gas you cannot see or smell. If you can smell the generator exhaust, you are breathing CO. But even if you cannot smell the exhaust, you could be breathing CO.

- Never use a generator inside homes, garages, crawlspaces, or other partly enclosed areas. Deadly levels of carbon monoxide can build up in these areas. Using a fan or opening windows and doors does NOT supply enough fresh air.
- ONLY use a generator outdoors and far away from open windows, doors, and vents. These openings can pull in generator exhaust.

Even when you use a generator correctly, CO may leak into the home. ALWAYS use a battery-powered or battery-backup CO alarm in the home.

If you start to feel sick, dizzy, or weak after the generator has been running, move to fresh air RIGHT AWAY. See a doctor. You could have carbon monoxide poisoning.



WARNING:

Read and understand all instructions. Failure to follow all instructions listed below could result in electrocution, fire, and/or carbon monoxide poisoning, which can cause death or serious injury.



WARNING:

National Electric Code requires generator to be grounded to an approved earth ground. Before using the ground terminal, consult a qualified electrician, electrical inspector, or local agency having jurisdiction for local codes or ordinances that apply to the intended use of the generator.

SAVE THESE INSTRUCTIONS

This manual contains important instructions for this product that should be followed during installation and maintenance of the generator.



- Do not connect to a building's electrical system unless the generator and transfer switch have been properly installed and the electrical output has been verified by a qualified electrician. The connection must isolate the generator power from utility power and must comply with all applicable laws and electrical codes.
- Do not allow children or untrained individuals to use this unit.
- Do not start or operate the engine in a confined space, building, near open windows, or in other unventilated space where dangerous carbon monoxide fumes can collect. Carbon monoxide, a colorless, odorless, and extremely dangerous gas, can cause unconsciousness or death.
- Keep all bystanders, children, and pets at least 3 meters away.

IMPORTANT SAFETY INSTRUCTIONS

- Wear sturdy and dry shoes or boots. Do not operate while barefoot.
- Do not operate generator when you are tired or under the influence of drugs, alcohol, or medication.
- Keep all parts of your body away from any moving parts and all hot surfaces of the unit.
- Do not touch bare wire or receptacles.
- Do not use generator with electrical cords which are worn, frayed, bare, or otherwise damaged.
- Before storing, allow the engine to cool and drain fuel from the unit.
- Do not operate or store the generator in rain, snow, or wet weather.
- Store the generator in a well-ventilated area with the fuel tank empty. Fuel should not be stored near the generator.
- Empty fuel tank, turn the engine/choke lever to the off position and restrain the unit from moving before transporting in a vehicle.
- Allow engine to cool for five minutes before refueling.
- To reduce the risk of fire and burn injury, handle fuel with care. It is highly flammable.
- Do not smoke while handling fuel.
- Store fuel in a container approved for petrol.
- Position the unit on level ground, stop engine, and allow to cool before refueling.
- Wipe spilled fuel from the unit.
- Loosen fuel cap slowly to release pressure and to keep fuel from escaping around the cap.
- Tighten the fuel cap securely after refueling.
- Never attempt to burn off spilled fuel under any circumstances.
- Generators vibrate in normal use. During and after the use of the generator, inspect the generator as well as extension cords and power supply cords connected to it for damage resulting from vibration. Have damaged items repaired or replaced as necessary. Do not use plugs or cords that show signs of damage such as broken or cracked insulation or damaged blades.
- For power outages, permanently installed stationary generators are better suited for providing back-up power to the home. Even a properly connected portable generator can become overloaded. This may result in overheating or stressing the generator components, possibly leading to generator failure.
- Use only authorized replacement parts and accessories and follow instructions in the Maintenance section of this manual. Use of unauthorized parts or failure to follow maintenance instructions may create a risk of shock or injury.
- Maintain the unit per maintenance instructions in this Operator's Manual.
- Inspect the unit before each use for loose fasteners, fuel leaks, etc. Replace damaged parts.

IMPORTANT SAFETY INSTRUCTIONS

SAFETY PRECAUTIONS

⚠ DANGER	
Using a generator indoors CAN KILL YOU IN MINUTES . Generator exhaust contains carbon monoxide. This is a poison you cannot see or smell.	
 NEVER use inside a home or garage, EVEN IF doors and windows are open.	 Only use OUTSIDE and far away from windows, doors, and vents.
Avoid other generator hazards. READ MANUAL BEFORE USE.	

⚠ WARNING

POISONOUS GAS HAZARD.



Engine exhaust contains carbon monoxide, a poisonous gas that could kill you in minutes. You **CANNOT** smell it, see it, or taste it. Even if you do not smell exhaust fumes, you could still be exposed to carbon monoxide gas.

- Operate this product **ONLY** outside far away from windows, doors and vents to reduce the risk of carbon monoxide gas from accumulating and potentially being drawn towards occupied spaces.
- Install battery-operated carbon monoxide alarms or plug-in carbon monoxide alarms with battery back-up according to the manufacturer's instructions. Smoke alarms cannot detect carbon monoxide gas.
- **DO NOT** run this product inside homes, garages, basements, crawlspaces, sheds, or other partially-enclosed spaces even if using fans or opening doors and windows for ventilation. Carbon monoxide can quickly build up in these spaces and can linger for hours, even after this product has shut off.
- **ALWAYS** place this product downwind and point the engine exhaust away from occupied spaces. If you start to feel sick, dizzy, or weak while using this product, shut it off and get to fresh air **RIGHT AWAY**. See a doctor. You may have carbon monoxide poisoning.

- If you start to feel sick, dizzy or weak while using the portable generator, you may have carbon monoxide poisoning. Get out side to fresh air immediately and call 000 for emergency medical attention. Very high levels of CO can rapidly cause victims to lose consciousness before they can rescue themselves. **DO NOT** attempt to shut off the generator before moving to fresh air. Entering an enclosed space where a generator is or has been running may put you at greater risk of CO poisoning.

IMPORTANT SAFETY INSTRUCTIONS

CORRECT USAGE WARNING

Example location to reduce risk of carbon monoxide poisoning

- ONLY use outside and downwind, far away from windows, doors and vents.
- Direct exhaust away from occupied spaces.

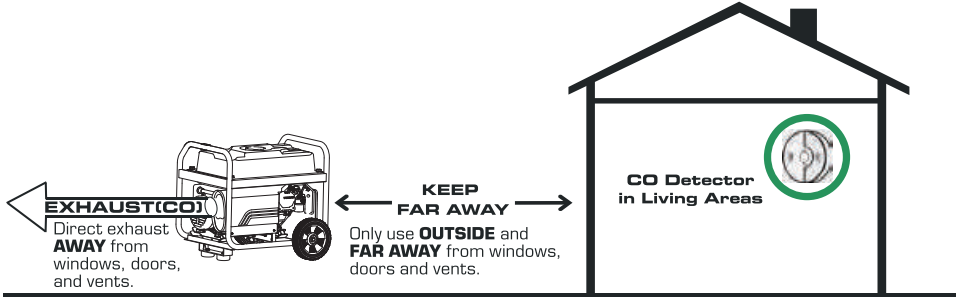

INCORRECT USAGE WARNING

Do not operate in any of the following locations:

- Near any door, window or vent
- Garage
- Basement
- Crawl Space
- Living Area
- Attic
- Entry Way
- Porch
- Mudroom

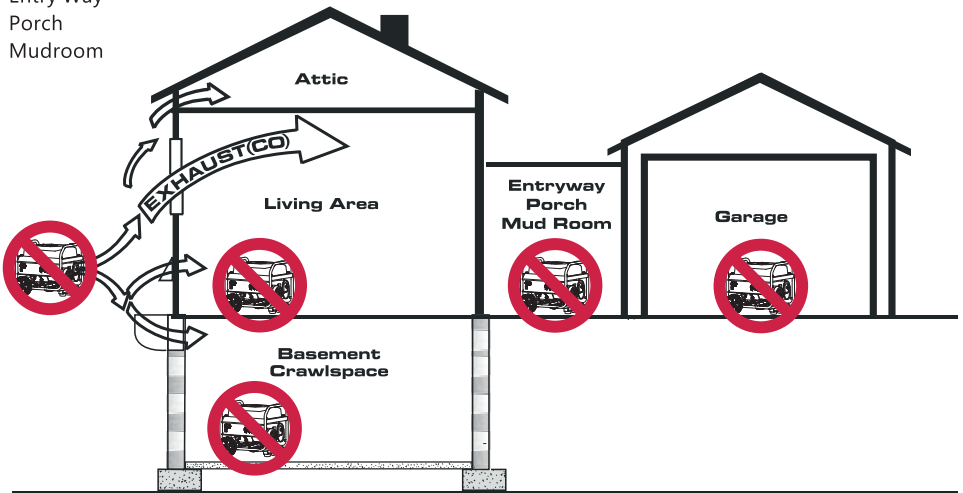

IMPORTANT SAFETY INSTRUCTIONS

WARNING



Starter cord kickback (rapid retraction) will pull hand and arm toward engine faster than you can let go which could cause broken bones, fractures, bruises, or sprains resulting in serious injury.

- When starting engine, pull cord slowly until resistance is felt and then pull rapidly to avoid kickback.
- **NEVER** start or stop engine with electrical devices plugged in and turned on.

WARNING



Fuel and its vapors are extremely flammable and explosive which could cause burns, fire, or explosion resulting in death or serious injury and/or property damage.

WHEN ADDING OR DRAINING FUEL

- Turn generator engine OFF and let it cool at least 2 minutes before removing fuel cap. Loosen cap slowly to relieve pressure in tank.
- Fill or drain fuel tank outdoors.
- **DO NOT** overfill tank. Allow space for fuel expansion.
- If fuel spills, wait until it evaporates before starting engine.
- Keep fuel away from sparks, open flames, pilot lights, heat, and other ignition sources.
- Check fuel lines, tank, cap, and fittings frequently for cracks or leaks. Replace if necessary.
- **DO NOT** light a cigarette or smoke.

WHEN STARTING EQUIPMENT

- Ensure spark plug, muffler, fuel cap, and air cleaner are in place.
- **DO NOT** crank engine with spark plug removed.

WHEN OPERATING EQUIPMENT

- **DO NOT** operate this product inside any building, carport, porch, mobile equipment, marine applications, or enclosure.
- **DO NOT** tip engine or equipment at angle which causes fuel to spill.
- **DO NOT** stop engine by moving choke control to "Start" position.

WHEN TRANSPORTING, MOVING OR REPAIRING EQUIPMENT

- Transport/move/repair with fuel tank EMPTY or with fuel shutoff valve OFF.
- **DO NOT** tip engine or equipment at angle which causes fuel to spill.
- Disconnect spark plug wire.

WHEN STORING FUEL OR EQUIPMENT WITH FUEL IN TANK

- Store away from furnaces, stoves, water heaters, clothes dryers, or other appliances that have pilot light or other ignition source because they could ignite fuel vapors.

WARNING

- This generator should not be used on marine applications.
- Failure to use the appropriate approved generator could result in death or serious injury and/or property damage.

WARNING



Generator voltage could cause electrical shock or burn resulting in death or serious injury.

- Use approved transfer equipment, suitable for the intended use, to prevent backfeed by isolating generator from electric utility workers.

IMPORTANT SAFETY INSTRUCTIONS

- When using generator for backup power, notify utility company.
- Use a ground fault circuit interrupter (GFCI) in any damp or highly conductive area, such as metal decking or steel work.
- **DO NOT** touch bare wires or receptacles.
- **DO NOT** use generator with electrical cords which are worn, frayed, bare or otherwise damaged.
- **DO NOT** operate generator in the rain or wet weather.
- **DO NOT** handle generator or electrical cords while standing in water, while barefoot, or while hands or feet are wet.
- **DO NOT** allow unqualified persons or children to operate or service generator.

WARNING



Exhaust heat/gases could ignite combustibles, structures or damage fuel tank causing a fire, resulting in death or serious injury and/or property damage.

Contact with muffler area could cause burns resulting in serious injury.

- **DO NOT** touch hot parts and **AVOID** hot exhaust gases.
- Allow equipment to cool before touching.
- Do not use or operate the engine on any forest-covered, brush-covered, or grass-covered land unless the exhaust system is equipped with a spark arrester, and is maintained in effective working order.

Contact the original equipment manufacturer, retailer, or dealer to obtain a spark arrester designed for the exhaust system installed on this engine.

- Replacement parts must be the same and installed in the same position as the original parts.

WARNING



Unintentional sparking could cause fire or electric shock resulting in death or serious injury.

WHEN ADJUSTING OR MAKING REPAIRS TO YOUR GENERATOR

- Disconnect the spark plug wire from the spark plug and place the wire where it cannot contact spark plug.

WHEN TESTING FOR ENGINE SPARK

- Use approved spark plug tester.
- **DO NOT** check for spark with spark plug removed.

WARNING



Starter and other rotating parts could entangle hands, hair, clothing, or accessories resulting in serious injury.

- **NEVER** operate generator without protective housing or covers.
- **DO NOT** wear loose clothing, jewelry or anything that could be caught in the starter or other rotating parts.
- Tie up long hair and remove jewelry.

CAUTION

Excessively high operating speeds could result in minor injury. Excessively low operating speeds impose a heavy load.

- **DO NOT** tamper with governor spring, links or other parts to increase engine speed. Generator supplies correct rated frequency and voltage when running at governed speed.
- **DO NOT** modify generator in any way.

NOTE:

Exceeding generators wattage/amperage capacity could damage generator and/or electrical devices connected to it.

- **DO NOT** exceed the generator's wattage amperage capacity.
- Start generator and let engine stabilize before connecting electrical loads.
- Connect electrical loads in OFF position, then turn ON for operation.
- Turn electrical loads OFF and disconnect from generator before stopping generator.

IMPORTANT SAFETY INSTRUCTIONS

NOTE:

Improper treatment of generator could damage it and shorten its life.

- Use generator only for intended uses.
- If you have questions about intended use, ask dealer or contact local service center.
- Operate generator only on level surfaces.
- DO NOT expose generator to excessive moisture, dust, dirt, or corrosive vapors.
- DO NOT insert any objects through cooling slots.
- If connected devices overheat, turn them off and disconnect them from generator.
- Shut off generator if:
 - Electrical output is lost.
 - Equipment sparks, smokes, or emits flames.
 - Unit vibrates excessively.



WARNING!

HAZARDOUS KEEP NEW AND USED BATTERIES OUT OF REACH OF CHILDREN.

Never allow children to replace button batteries on any device. Swallowing or placing inside any part of the body may lead to severe or fatal injuries in as little as 2 hours or less due to chemical burns and potential perforation of the oesophagus.

If you suspect your child has swallowed a button battery or placed inside any part of the body, immediately call the POISONS INFORMATION CENTRE on 13 11 26 for prompt advice. If your child is having any difficulty breathing, contact 000. Dispose of used button/ coin batteries immediately and safely. A battery can still be dangerous even when it can no longer operate the device. Place sticky tape around both sides of the battery and dispose of it immediately out of reach of children in an outside bin or recycle safely.

⚠ WARNING

Medical and Life Support Uses.

- In case of emergency, call 000 immediately.
- NEVER use this product to power life support devices or life support appliances.
- NEVER use this product to power medical devices or medical appliances.
- Inform your electricity provider immediately if you or anyone in your household depends on electrical equipment to live.
- Inform your electrical provider immediately if a loss of power would cause you or anyone in your household to experience a medical emergency.

IMPORTANT SAFETY INSTRUCTIONS



WARNING:

When this generator is used to supply a building wiring system: generator must be installed by a qualified electrician and connected to a transfer switch as a separately derived system. The generator shall be connected through a transfer switch that switches all conductors other than the equipment grounding conductor. The frame of the generator shall be connected to an approved grounding electrode. Failure to isolate the generator from power utility can result in death or injury to electric utility workers.



- Do not use this generator to provide power for emergency medical equipment or life support devices.
- Exhaust contains poisonous carbon monoxide, a colorless, odorless gas. Breathing exhaust can cause loss of consciousness and can lead to death. If running in a confined or partially-enclosed area, the air may contain a dangerous amount of carbon monoxide. To keep exhaust fumes from building up, always provide adequate ventilation.
- Always use a battery-powered carbon monoxide detector when running the generator. If you begin to feel sick, dizzy, or weak while using the generator, shut it off and get to fresh air immediately. See a doctor. You may have carbon monoxide poisoning.
- Place the generator on a flat, stable surface with a slope of no more than 4°.
- Operate outdoors in a well-ventilated, well-lit area isolated from working areas to avoid noise interference.
- Operate outdoors in a well-ventilated, well-lit area isolated from working areas to avoid noise interference.
- Operating the generator in wet conditions could result in electrocution. Keep the unit dry.
- Keep the generator a minimum of 1 meter away from all types of combustible material.
- Do not operate generator near hazardous material.
- Do not operate generator at a gas or natural gas filling station.
- Do not touch the muffler or cylinder during or immediately after use; they are HOT and will cause burn injury.
- This generator has a neutral floating condition. This means the neutral conductor is not electrically connected to the frame of the machine.
- Do not allow the generator's fuel tank to overflow when filling. Fill to 3cm below the top neck of the petrol tank to allow for fuel expansion. Do not cover the fuel tank cap when the engine is running. Covering the fuel tank cap during use may cause engine failure and/or damage to the tool.

IMPORTANT SAFETY INSTRUCTIONS

- Do not smoke when filling the generator with fuel.
- Shut down the engine and allow to cool completely before adding petrol or lubricant to the generator.
- Do not remove the oil dipstick or the fuel tank cap when the engine is running.
- Pay close attention to all safety labels located on the generator.
- Keep children a minimum of 3 m away from the generator at all times.
- The unit operates best in temperatures between -5°C and 40°C with a relative humidity of 90% or less.
- Operating voltage and frequency requirement of all electronic equipment should be checked prior to plugging them into this generator. Damage may result if the equipment is not designed to operate within a $\pm 10\%$ voltage variation, and ± 3 hz frequency variation from the generator name plate ratings.
- For outdoor use only.
- Save these instructions. Refer to them frequently and use them to instruct others who may use this product. If you loan someone this product, loan them these instructions also.

SYMBOLS

The following signal words and meanings are intended to explain the levels of risk associated with this product.

SYMBOL	SIGNAL	MEANING
	DANGER:	Indicates an imminently hazardous situation, which, if not avoided, will result in death or serious injury.
	WARNING:	Indicates a potentially hazardous situation, which, if not avoided, could result in death or serious injury.
	CAUTION:	Indicates a potentially hazardous situation, which, if not avoided, may result in minor or moderate injury.
	NOTICE:	(Without Safety Alert Symbol) Indicates important information not related to an injury hazard, such as a situation that may result in property damage.

SYMBOLS

SAFETY LABELS

The information below can be found on the generator. For your safety, please study and understand all of the labels before starting the generator.



LEFT MAINTENANCE COVER

- Spark plug inspection/replacement.
- Air filter inspection/cleaning. (need to remove the covers on both sides)

TO OPEN:

- Loosen both screws - counter clockwise.
- Remove cover.



Air Cleaner Access



Spark Plug Service

Spark Plug: **NGK BPR6ES**

Champion	RM11YC
Bosch	WR6DC
Torch	FR1TC



RIGHT MAINTENANCE COVER

- Remove for servicing engine oil.
- Battery inspection/replacement.
- Spark plug inspection/replacement.
- Air filter inspection/cleaning. (need to remove the covers on both sides)

TO OPEN:

- Loosen both screws - counter clockwise.
- Remove cover.



Battery Compartment



Air Cleaner Access



Spark Plug Service

Spark Plug: **NGK BPR6ES**

Champion	RM11YC
Bosch	WR6DC
Torch	FR1TC



MAXWATT
POWER WHEN YOU NEED IT

MX13000iS

PETROL INVERTER GENERATOR

⚠ DANGER

 Risk of fire. Check for any fuel overflow or leakage. Stop the engine before refueling.

 Failure to properly ground generator can result in electrocution, especially if the generator is equipped with a wheel kit.

 Generator is a potential source of electric shock. Do not expose to moisture, rain, or snow. Do not operate with wet hands or feet.

⚠ DANGER

 Exhaust contains poisonous carbon monoxide gas that can cause unconsciousness or DEATH. Operate in well ventilated, outdoor areas away from open windows or doors.

 You could be killed or seriously hurt if you do not follow the Operator's Manual instructions.

 Do not expose to rain or use in damp locations.

⚠ WARNING

Using a generator indoors **CAN KILL YOU IN MINUTES**. Generator exhaust contains carbon monoxide. This is a poison you cannot see or smell.



NEVER use inside a home or garage, **EVEN IF** door and windows are open.



Only use **OUTSIDE** and far away from windows, doors, and vents.

Product does not include grounding rod or copper wire. National Electric Code requires generator to be properly grounded to an approved earth ground. Call an electrician for local grounding requirements.

CAUTION



HOT SURFACE



DON'T TOUCH



ELECTRICAL

GENERATOR CAPACITY

Make sure the generator can supply enough continuous (running) and surge (starting) watts for the items you will power at the same time. Follow these simple steps.

1. Select the items you will power at the same time.
2. Total the continuous (running) watts of these items. This is the amount of power the generator must produce to keep the items running. See the wattage reference chart at right.
3. Estimate how many surge (starting) watts you will need. Surge wattage is the short burst of power needed to start electric motor-driven tools or appliances such as a circular saw or refrigerator. Because not all motors start at the same time, total surge watts can be estimated by adding only the item(s) with the highest additional surge watts to the total rated watts from step 2.

Example:

Tool or Appliance	Running Watts*	Starting Watts*
Window AC, 10,000 BTU	1200	1800
Refrigerator	700	2200
1/3 HP Well Pump	1000	2000
27 in. Television	500	0
Light (75 Watts)	75	0
	3475 Total Running Watts	2200 Highest Starting Watts

Total Running Watts	3475
Highest Starting Watts	+ 2200
Total Starting Watts Needed	5675

NOTICE:

Do not overload the generator's capacity. Exceeding the generator's wattage/amperage capacity may damage the generator and/or electrical devices connected to it.

Application/Equipment	Estimated Running Watts*	Estimated Starting Watts*
Emergency / Home Standby		
Clock Radio	50	0
Lights (qty. 4 x 75 W)	300	0
Refrigerator	700	2200
Furnace Fan	800	2350
Water Well Pump	1000	1500
Microwave	1000	1000
Sump Pump	1050	2200
Electric Range (per element)	2100	0
Job Site		
Electric Drill – 1/2 HP	600	900
Airless Sprayer – 1/3 HP	600	1200
Quartz Halogen Work Light	1000	1000
Reciprocating Saw	960	1920
Air Compressor – 1 HP	1600	4500
Circular Saw – 7-1/4 in.	1400	2300
Planer/Joiner – 6 in	1800	1800
Miter Saw – 10 in.	1800	1800
Table Saw/Radial Arm Saw – 10 in.	2000	2000

*Wattages listed are approximate. Check tool or appliance for actual wattage.

POWER MANAGEMENT

To prolong the life of the generator and attached devices, it is important to take care when adding electrical loads to the generator. There should be nothing connected to the generator outlets before starting its engine. The correct and safe way to manage generator power is to sequentially add loads as follows:

1. With nothing connected to the generator, start the engine as described later in this manual.
2. Plug in and turn on the first load, preferably the largest load you have.
3. Permit the generator output to stabilize (engine runs smoothly and attached device operates properly).
4. Plug in and turn on the next load.
5. Again, permit the generator to stabilize.
6. Repeat steps 4 and 5 for each additional load.

Never add more loads than the generator capacity. Take special care to consider surge loads in generator capacity as previously described.

ELECTRICAL

GENERATOR CAPACITY

To prolong the life of the generator and attached devices, it is important to take care when adding electrical loads to the generator. There should be nothing connected to the generator outlets before starting its engine. The correct and safe way to manage generator power is to sequentially add loads as follows:

1. With nothing connected to the generator, start the engine as described later in this manual.
2. Plug in and turn on the first load, preferably the largest load you have.
3. Permit the generator output to stabilize (engine runs smoothly and attached device operates properly).
4. Plug in and turn on the next load.
5. Again, permit the generator to stabilize.
6. Repeat steps 4 and 5 for each additional load.

Never add more loads than the generator capacity. Take special care to consider surge loads in generator capacity as previously described.

NOTICE:

Do not overload the generator's capacity. Exceeding the generator's wattage/ampere capacity may damage the generator and/or electrical devices connected to it.

FEATURES

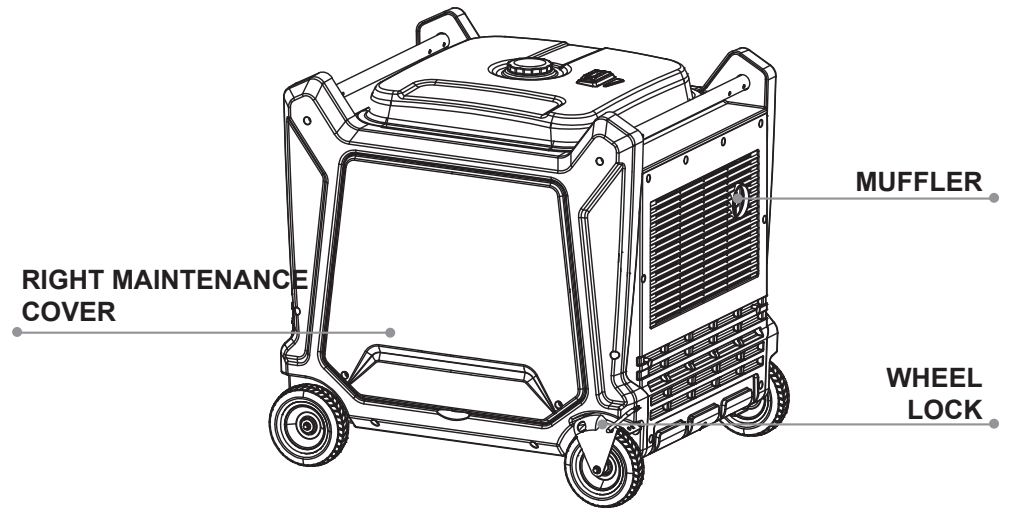
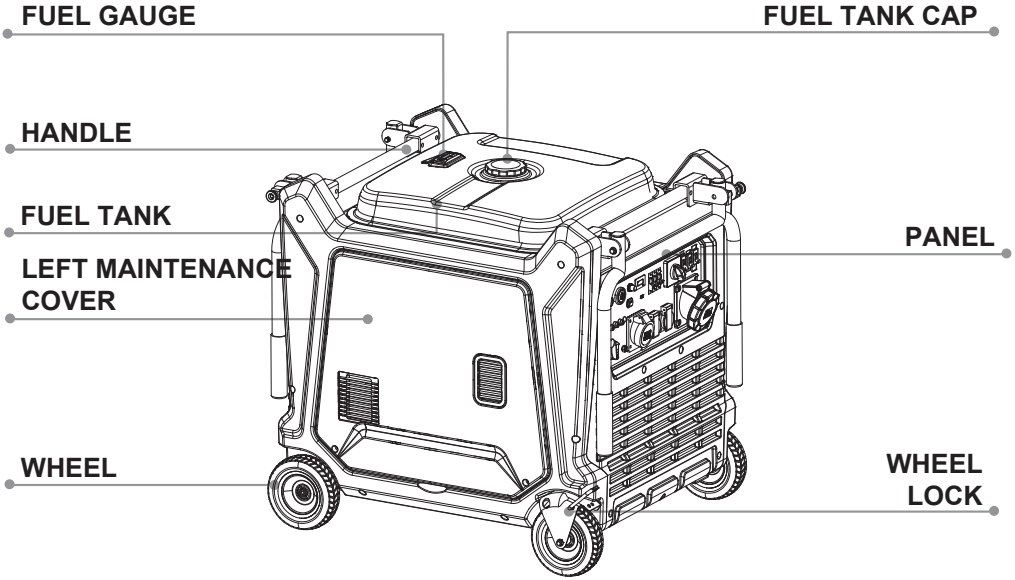

FEATURES

CONTROL PANEL

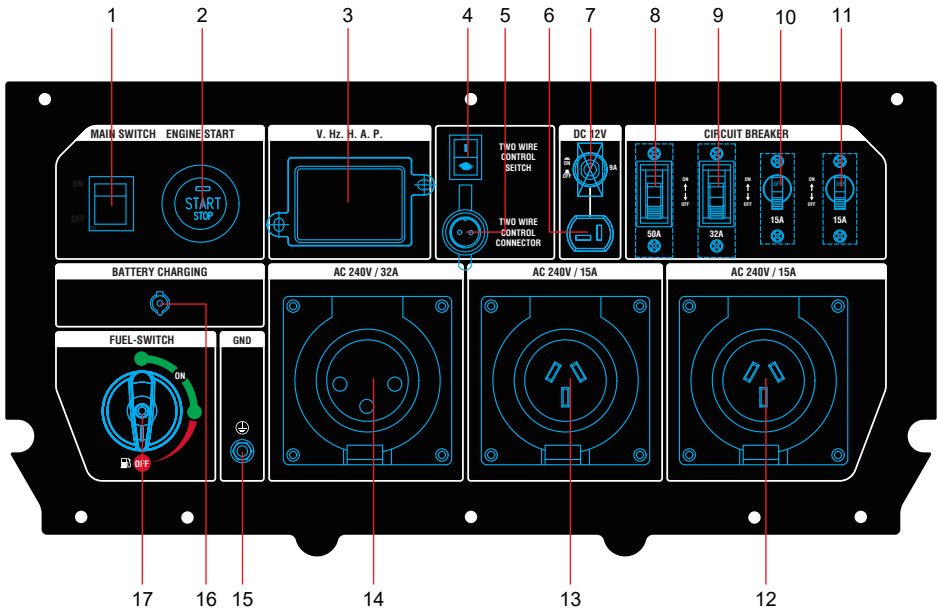

1	Main Switch	10	Circuit Breaker
2	Engine Start Button	11	Circuit Breaker
3	Multi-function Digital Display Table	12	AC Out 240V/15A
4	Two Wire Control Switch	13	AC Out 240V/15A
5	Two Wire Control Connector	14	AC Out 240V/32A
6	DC 12V	15	Ground
7	DC Circuit Breaker	16	Battery Charging
8	Main Circuit Breaker	17	Fuel-switch
9	Circuit Breaker		

FEATURES

KNOW YOUR GENERATOR

The safe use of this product requires an understanding of the information on the product and in this operator's manual as well as a knowledge of the project you are attempting. Before use of this product, familiarize yourself with all operating features and safety rules.

AC RECEPTACLES

The receptacles can be used for operating appropriate appliances, electrical lighting, tools, and motor loads.

AIR FILTERS

The air filters help to limit the amount of dirt and dust drawn into the unit during operation.

LOW IDLE MODE

The low idle mode is used to control the speed of the engine and conserve fuel. When the switch is in the ON (I) position and no appliances are connected to the unit, the engine will idle. If an appliance is added, the engine speed will increase to power the item. If the appliance is removed, the engine will return to idle.

NOTICE:

If high electrical loads are connected simultaneously, turn the low idle mode to the OFF position to reduce voltage changes.

HANDLES

The generator is equipped with two handles for easy transport. Both handles should be used to move the generator.

FUEL TANK

To provide increased operating time, start with a full tank before operation. Always refuel with the engine OFF and cool.

FUEL GAUGE

The fuel gauge is a mechanical device that measures the fuel level in the tank. The red indicator in the window will reference the level in relation to full or empty.

GROUND TERMINAL

The ground terminal is used to assist in properly grounding the generator to help protect against electrical shock. Consult with a local electrician for grounding requirements in your area.

LED DISPLAY

LEDs provide feedback to indicate whether the generator is in use, overloaded, or in need of lubricant.

OIL CAP/DIPSTICK

Remove the oil fill cap to check and add lubricant to the generator when necessary.

FEATURES

DC RECEPTACLE (Optional)

Your generator has a 12 volt DC receptacle for charging lead acid batteries.

MULTI-SWITCH

The multi-switch is used to control the fuel and choke.

MAINTENANCE COVER

Open and close the maintenance cover for maintenance of the generator.

Open the right maintenance cover for:

- Air filter inspection/cleaning
- Spark plug inspection/replacement
- Battery inspection/replacement

Open the left maintenance cover for:

- Engine oil inspection/replacement

ASSEMBLY

UNPACKING

This product has been shipped completely assembled.

- Carefully remove the product and any accessories from the box. Make sure that all items listed in the packing list are included.



WARNING:

Do not use this product if any parts on the Packing List are already assembled to your product when you unpack it. Parts on this list are not assembled to the product by the manufacturer and require customer installation. Use of a product that may have been improperly assembled could result in serious personal injury.

- Inspect the product carefully to make sure no breakage or damage occurred during shipping.
- Do not discard the packing material until you have carefully inspected and satisfactorily operated the product.
- If any parts are damaged or missing, please call for assistance.



WARNING:

If any parts are damaged or missing do not operate this product until the parts are replaced. Use of this product with damaged or missing parts could result in serious personal injury.



WARNING:

Do not attempt to operate the generator until assembly is complete. Failure to comply could result in possible serious personal injury.



WARNING:

Do not attempt to modify this product or create accessories not recommended for use with this product. Any such alteration or modification is misuse and could result in a hazardous condition leading to possible serious personal injury.

PACKING LIST

Generator
Battery Charging Cable (Optional)
Engine Lubricant (Optional)
Screwdriver
Funnel
Operator's Manual

OPERATION

DANGER:

Carbon Monoxide. Using a generator indoors **CAN KILL YOU IN MINUTES.**

Generator exhaust contains high levels of carbon monoxide (CO), a poisonous gas you cannot see or smell. If you can smell the generator exhaust, you are breathing CO. But even if you cannot smell the exhaust, you could be breathing CO.

- Never use a generator inside homes, garages, crawlspaces, or other partly enclosed areas. Deadly levels of carbon monoxide can build up in these areas. Using a fan or opening windows and doors does NOT supply enough fresh air.
- ONLY use a generator outdoors and far away from open windows, doors, and vents. These openings can pull in generator exhaust.

Even when you use a generator correctly, CO may leak into the home. ALWAYS use a battery-powered or battery-backup CO alarm in the home.

If you start to feel sick, dizzy, or weak after the generator has been running, move to fresh air RIGHT AWAY. See a doctor. You could have carbon monoxide poisoning.

WARNING:

Do not allow familiarity with this product to make you careless. Remember that a careless fraction of a second is sufficient to inflict serious injury.

DANGER:

Failure to properly ground generator can result in electrocution, especially if the generator is equipped with a wheel kit. Call an electrician for local grounding requirements.

GROUNDING THE GENERATOR

To reduce the risk of shock or electrocution, generator must be properly grounded. The nut and ground terminal on the frame must always be used to connect the generator to a suitable ground source. Connect the terminal of the ground wire between the lock washer and the nut, and tighten the nut fully. Connect the other end of the wire securely to a suitable ground source.

All electrical tools and appliances operated from this generator must be properly grounded by use of a third wire or be "Double Insulated."

Check and adhere to all applicable federal, state, and local regulations relating to grounding specifications. Consult a qualified electrician or service personnel if the grounding instructions are not completely understood or if in doubt as to whether the generator is properly grounded.

WARNING:

Do not use any attachments or accessories not recommended by the manufacturer of this product. The use of attachments or accessories not recommended can result in serious personal injury.

OPERATION

CONNECTING BATTERY

WARNING:

To reduce the risk of electrocution or explosion, do not short circuit the battery terminals or charge in a sealed container. Keep sparks and flame away.

WARNING:

Keep metal objects away from the battery terminals. Metal objects can make a connection from one terminal to another. Shorting the battery terminals together can cause sparks, burns, or a fire.

NOTICE:

The battery may require charging before the generator can be started using either the engine switch or the recoil starter. Once the generator is started, the battery will charge as the unit runs.

The battery cables must be connected before the generator can be operated.

To connect battery cables:

- Loosen the screws at the side of the right maintenance cover. Remove cover and set aside.
- Connect the red wires to the positive (+) terminal first, then connect the black wire to the negative (-) terminal. Make sure all connections are tight.
- Cover the terminals with the rubber covers.

NOTE: Be careful not to short across the terminals when installing. Shorting the terminals together can cause sparks, damage to the battery or generator, or even burns or explosions.

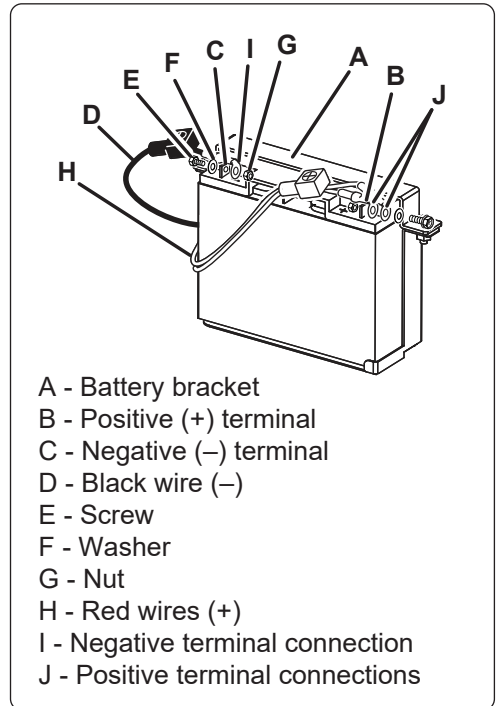
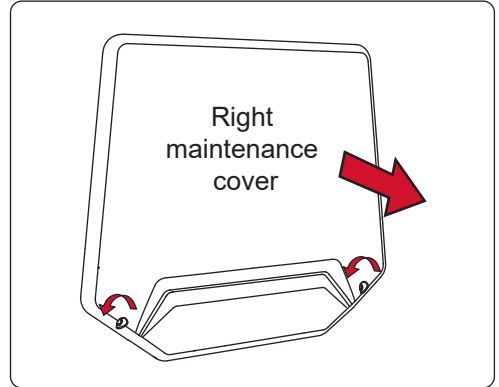

OPERATION

CHECKING/ADDING ENGINE OIL

The generator is equipped with two handles for easy transport. Both handles should be used to move the generator.

NOTICE:

Attempting to start the engine before it has been properly filled with engine oil will result in equipment failure.

Engine oil has a major influence on engine performance and service life. For general, all-temperature use, SAE 10W-30 is recommended. Always use a 4-stroke engine oil that meets or exceeds the requirements.

NOTE: Non-detergent or 2-stroke engine oil will damage the engine and should not be used.

- Loosen the screws at the side of the left maintenance cover. Remove cover and set aside.
- Unscrew the oil cap/dipstick and remove.
- Wipe dipstick clean and re-seat in hole; do not re-thread.
- Remove dipstick again and check engine oil level. Engine oil level should fall between the minimum and maximum marks on the dipstick.
- If level is low, add engine oil.
- Replace and secure the cap/dipstick.

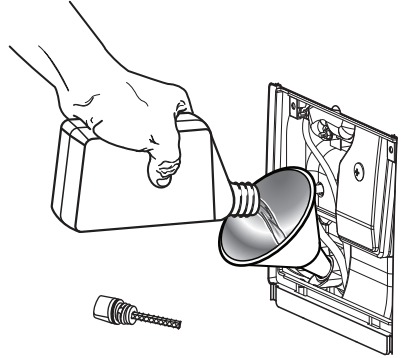
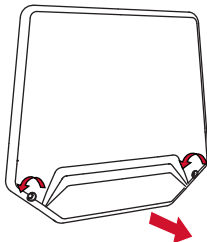

USING FUEL STABILIZER

Fuel gets old, oxidizes, and breaks down over time. Adding a fuel stabilizer (not included) extends the usable life of fuel and helps prevent deposits from forming that can clog the fuel system. Follow fuel stabilizer manufacturer's directions for correct ratio of stabilizer to fuel.

- Mix fuel stabilizer and fuel prior to filling the tank by using a gas can or other approved fuel container and shaking gently to combine.

NOTE: To control the amount of fuel stabilizer being added to the engine, always mix fuel stabilizer with fuel before fueling the tank rather than adding fuel stabilizer directly into the generator's fuel tank.

- Replace and secure fuel tank cap.
- Start and run the engine for at least 5 minutes to allow stabilizer to treat the entire fuel system.

OPERATION

OXYGENATED FUELS

NOTICE:

Do not use E15 or E85 fuel (or fuel containing greater than 10% ethanol) in this product. It is a violation of federal law and will damage the unit and void your warranty.

Fuel system damage or performance problems resulting from the use of an oxygenated fuel containing more than the percentage of oxygenates stated below **are not covered under warranty.**

Ethanol. Petrol containing up to 10% ethanol by volume (commonly referred to as E10) is acceptable. **E15 and E85 are not.**

CHECKING/ADDING FUEL

⚠ WARNING:

Petrol and its vapors are highly flammable and explosive. To prevent serious personal injury and property damage, handle gasoline with care. Keep away from ignition sources, handle outdoors only, do not smoke while adding fuel, and wipe up spills immediately.

When adding fuel to the generator, make sure the unit is sitting on a flat, level surface. If the engine is hot, let the generator cool before adding gas. **ALWAYS** fill the fuel tank outdoors with the machine turned off.

- Remove the fuel cap.
- Fill the fuel tank to 1 in. below the top of the fuel neck.

- Replace and secure the fuel cap.

NOTE: Always use unleaded petrol with a pump octane rating of 86 or higher. Never use old, stale, or contaminated petrol, and do not use an oil/gas mixture. Do not allow dirt or water into the fuel tank. **Do not use E85 fuel.**

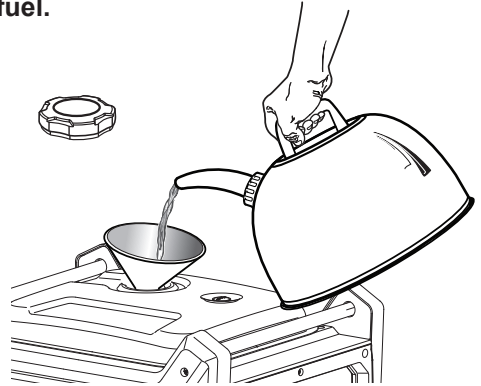

OPERATION

STARTING YOUR GENERATOR

Before starting the generator:

1. Verify that the generator is outside on a dry, level surface. Allow at least 1 meter of clearance on all sides of the generator.
2. To maximize safety, check that the generator is properly grounded (see “GROUND THE GENERATOR”).
3. Check there is sufficient level of oil in the crankcase. Add oil if necessary (see “ADD/CHECK OIL”).
4. Make sure there is sufficient level of gasoline in the fuel tank. Add fuel if necessary (see “ADD/CHECK FUEL”).
5. Make sure all electrical devices are unplugged from the generator during ignition. Otherwise it will be difficult for the engine to start.

To start the generator, perform the following steps:

1. Turn the FUEL switch (Fig. 1) to “ON”.

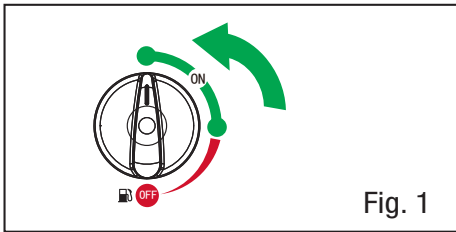

2. Turn the ENGINE switch (Fig. 2) to “ON”.

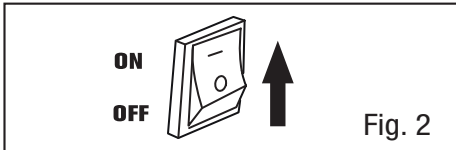

3. Press the START switch and hold on for 5 seconds (Fig. 3).



NOTE: If the engine does not start, release the switch and try again. Keeping the switch in the START position too long can damage the starter.

OPERATION

SHUTTING OFF THE GENERATOR

⚠ CAUTION: Unplugging running devices can cause damage to the generator. Never stop the engine with electrical devices connected and running.

1. Turn off all electrical devices prior to unplugging them from the generator. Unplugging running devices can cause damage to the generator.
2. Allow generator to run at no load for a few minutes to stabilize internal temperatures.
3. Turn the ENGINE switch to the “OFF” position (Fig. 4).
4. Turn the FUEL Switch to the “OFF” position (Fig. 4).

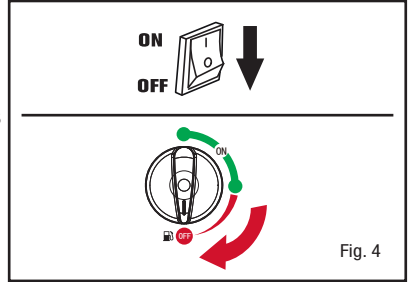

⚠ WARNING: Allow the generator to cool down before touching areas that become hot during use.

CAUTION: Allowing petrol to sit in the fuel tank for long periods of time can make it difficult to start the generator in the future. NEVER store the generator for extended periods of time (over 2 months) with fuel in the fuel tank. Refer to “STORING THE GENERATOR”.

AC APPLICATIONS

Before connecting an appliance or power cord to the generator:

- Make sure that it is in good working order. Faulty appliances or power cords can create a potential for electrical shock.
- If an appliance begins to operate abnormally, becomes sluggish, or stops suddenly, turn it off immediately. Disconnect the appliance, and determine whether the problem is the appliance or the rated load capacity of the generator has been exceeded.

Most appliance motors require more than their rated wattage for startup.

Make sure the electrical rating of the tool or appliance does not exceed the maximum power rating of the generator.

In either case, the total power requirements of all appliances connected must be considered. Appliance and power tool manufacturers usually list rating information near the model number or serial number.

OPERATION

STANDBY POWER

Connections to a Building's Electrical System

Connections for standby power to a building's electrical system must be made by a qualified electrician. The connection must isolate the generator power from utility power, and must comply with all applicable laws and electrical codes.

In some areas, generators are required by law to be registered with local utility companies. Check local regulations for proper registration and use procedures.

2 WIRE AUTO START

Automatic Electric Starting of the MX13000iS by 2-Wire Auto Start.

1. Verify the battery is properly installed and both battery cables are attached.
2. If the generator is left in non-operate standby whilst in auto-start mode for an extended period or it starts and stops frequently with a short operating time, the battery may become excessively discharged and unable to automatically start the generator. To ensure reliable service, it is recommended that the battery be connected in parallel to a main(12V) or solar-powered automatic maintenance battery charger(12V).
3. Connect electrical cords or devices into the 240-Volt AC or 12-Volt DC outlets, as required.
4. Switch the 240-Volt AC Main Circuit

Breaker to the ON position and ensure that the DC breaker is pushed in.

5. Connect the 2-wire auto start terminals to an external "dry" or voltage-free circuit that will provide the start and stop commands to the generator by closing and opening the circuit, respectively.
6. Move the fuel shut off valve to the ON position.
7. Push the auto start control switch to the ON position.
8. Do not touch the choke lever. It will automatically adjust itself to the correct position if the generator's battery is sufficiently charged.
9. Upon receiving a "start" signal by closing of the external 2 wire remote control circuit, the generator will start automatically. The generator will continue running until it receives a remote "stop" command or is manually stopped or runs out of fuel.
10. When the two-wire control switch is pressed ON, the one-key start, cannot control the starting of the generator set.
11. Only the two-wire control socket (two core aviation) socket can control the start and stopping of the generator set.
12. After 48 hours of turning off the generator set with the one-key start, the generator set will enter the power saving mode. At this time, only the "one-key start" switch will reenergize the generator set to wake up the starter module.

OPERATION

13. Only after the gen set has been woken then the start stop function of the generator set can be controlled again.
14. When the two-wire control switch is pressed OFF, only the one -key starter, can control the starting or stopping of the generator set.



WARNING:

Improper connections to a building's electrical system can allow current from the generator to back feed into the utility lines.

Such backfeed may electrocute utility company workers or others who contact the lines during a power outage, and the generator may explode, burn, or cause fires when utility power is restored.

Consult the utility company or a qualified electrician prior to making any power connections.

HIGH ALTITUDE OPERATION

Specific modifications are needed for high-altitude operation. Please contact your authorized service center for important information regarding these modifications. Operating this engine without the proper altitude modification may increase the engine's emissions and decrease fuel economy and performance.

MAINTENANCE

WARNING:

When servicing, use only identical replacement parts. Use of any other parts could create a hazard or cause product damage.

GENERAL MAINTENANCE

Keep the generator in a clean and dry environment where it is not exposed to dust, dirt, moisture, or corrosive vapors. Do not allow the cooling air slots in the generator to become clogged with foreign material such as leaves, etc.

Do not use a garden hose to clean the generator. Water entering the fuel system or other internal parts of the unit can cause problems that will decrease the life of the generator.

CHECKING/CLEANING AIR FILTER

For proper performance and long life, keep air filter clean.

- Loosen the screws at the both sides maintenance cover. Remove cover and set aside.
- Unsnap the air filter cover clip, pulling the cover down and off the unit, remove air filter cover and set aside.
- Remove the air filter.
- Wash the air filters with warm, soapy water. Rinse and squeeze to dry.
- Reinstall the air filters.

NOTE: Make sure the filters are seated properly inside the generator. Installing the filters incorrectly will allow dirt to enter the engine, causing rapid engine wear.

- Reinstall the air filter cover.
- Reinstall the right maintenance cover. Tighten screws to secure.

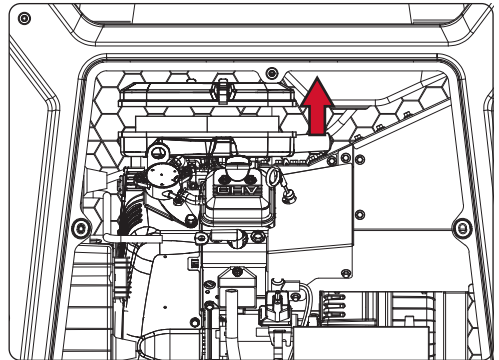
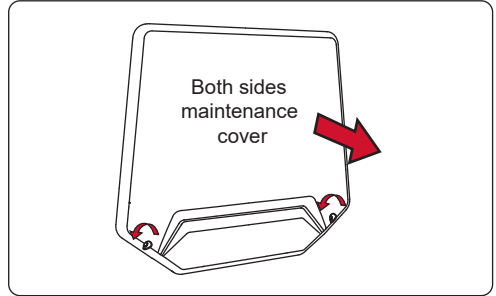

CHANGING ENGINE OIL

For best performance, engine oil should be changed after every 100 hours or 6 months of operation.

NOTE: Drain the engine oil while the engine is still warm but not hot. Warm engine oil will drain quickly and more completely.

- Loosen the screws at the side of the right maintenance cover. Remove cover and set aside.

MAINTENANCE

- Reach under the generator and remove the black rubber seal located below the oil drain plug.
- Place a suitable container underneath the generator to catch the used oil.
- Remove the oil fill cap/dipstick.
- Remove the other black rubber seal located in the front the oil drain plug.
- Use a wrench through the hole remove the oil drain plug and allow the oil to drain completely.
- Reinstall the oil drain plug. Tighten the plug securely.
- Reinstall the two black rubber seal (the front one and the bottom one).
- With the generator in a level position and refill with engine oil following the instructions in the Checking/Adding engine oil section previously in this manual. For amount of engine oil needed to refill, see Product Specifications earlier in this manual or the accompanying engine manual, if applicable.
- Reinstall the oil cap/dipstick securely.
- Reinstall the left maintenance cover. Tighten screws to secure.

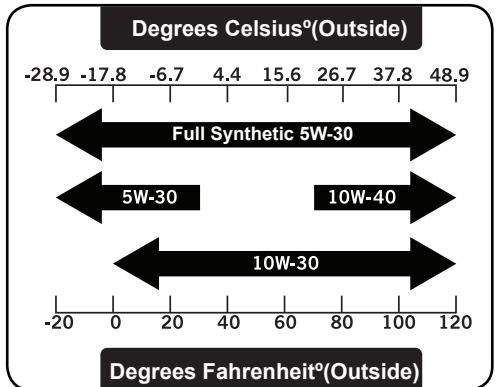
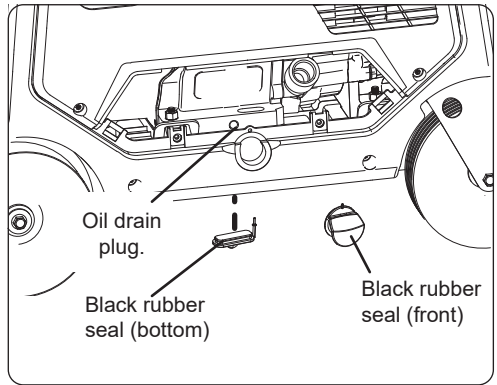
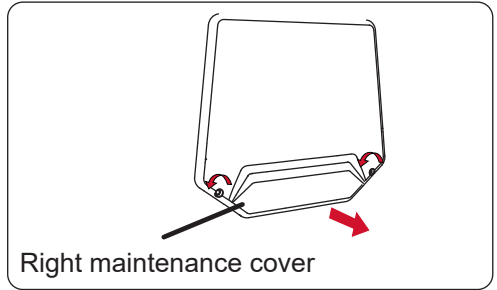

NOTE: Used engine oil should be disposed of at an approved disposal site. See local retailer for more information.

WARNING:

Do not change engine oil while it is hot. Accidental contact with hot engine oil could result in serious burns.

MAINTENANCE

SPARK PLUG REPLACEMENT

The spark plug must be properly gapped and free of deposits in order to ensure proper engine operation. If the engine is hot, allow it to cool before servicing the spark plug.

- Loosen the screws at the side of the right maintenance cover. Remove cover and set aside.
 - Remove the spark plug cap.
 - Clean any dirt from around base of spark plug.
 - Remove spark plug using spark plug wrench.
 - Inspect the spark plug. Replace it if the electrode is worn or fouled, or if the insulator is cracked or chipped.
 - Measure the spark plug electrode gap with a wire-type feeler gauge. Correct the gap, if necessary, by carefully bending the side electrode. The gap should be:
0.028-0.031 in (0.7-0.8mm)
 - Seat spark plug in position; thread in by hand to prevent cross-threading.
If reinstalling a used spark plug, tighten 1/8-1/4 turn after the spark plug seats.
If installing a new spark plug, tighten 1/2 turn after the spark plug seats.
- NOTE:** An improperly tightened spark plug will become very hot and could damage the engine.

NOTICE:

Be careful not to cross-thread the spark plug. Cross-threading will seriously damage the product.

- Attach the spark plug cap.
- Close the right maintenance cover.
- Recommend spark plug.

Spark Plug Service



GAP:
0.7mm
or
0.028"

Spark Plug: NGK BPR6ES
Champion RN11YC
Bosch WR6DC
Torco F6RTC

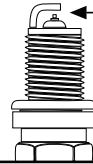

0.7 - 0.8 mm
0.028 - 0.031 in.

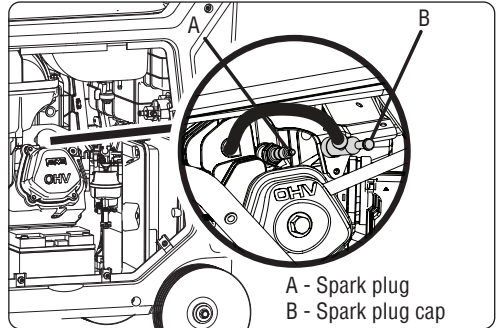

A - Spark plug
B - Spark plug cap

SPARK ARRESTER SERVICE

The spark arrester must be serviced every 100 hours to keep it functioning as designed.

If the engine has been running, the muffler will be very hot. Allow the muffler to cool before servicing spark arrester.

- Remove the two screws, and remove the tail pipe and spark arrester.
- Use a brush to remove carbon deposits from the spark arrester screen. Be careful to avoid damaging the screen.

The spark arrester must be free of breaks and tears. Replace the spark arrester if it is damaged.

MAINTENANCE

- Install the spark arrester in the reverse order of removal.

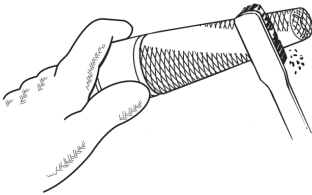

DRAINING FUEL TANK / CARBURETOR

To help prevent gum deposits in the fuel system, drain the fuel from the tank and carburetor before storing.

Draining the fuel tank:

Remove the fuel tank cap, remove the fuel strainer, and empty the fuel tank into an approved petrol container. We recommend using a commercially available petrol hand pump to empty the tank. Do not use an electric pump. Siphon the petrol by inserting the tip of the hand pump into the side of the pump guard. Reinstall the fuel strainer and the fuel tank cap..

Draining the carburetor:

- Loosen the screws at the side of the right maintenance cover. Remove cover and set aside.
- Turn the Multi-switch to the RUN position.
- Position a suitable container under the carburetor drain screw to catch fuel; loosen the screw.

- Allow fuel to drain completely into container.
- Retighten drain screw securely.
- Turn the Multi-switch to the OFF position.

TRANSPORTING

- Turn the Multi-switch to the OFF position.
- Make sure engine and exhaust of unit is cool.
- Keep the generator level to reduce the possibility of fuel leakage.
- When using ropes or tie-down straps to secure the generator for transportation, be sure to only use the frame bars as attachment points. Do not fasten ropes or straps to any portions of the generator body or the folding transport handle.

BATTERY CHARGING

- Start the engine first and allow it to reach idle before connecting the generator to the battery. Battery Charging is performed using the 12V DC outlet only.
- Be sure the Throttle switch is turned "OFF" while charging the batteries.
- Be sure to connect the red battery charger lead to the positive (+) battery terminal, and connect the black lead to the negative (-) battery terminal. DO NOT reverse the positions.
- Connect the battery charger leads to

MAINTENANCE

the battery terminals securely so that they do not disconnect due to the engine vibration or other disturbances.

- Change the battery by following the instructions in the owner's manual of the battery.
- The DC Circuit Breaker will turn "OFF" automatically if the current exceeds the rated output.
- To restart charging the battery, turn the DC protector on by pressing its button to the "ON" position.
- Refer to the owner's manual of the battery to determine charging times.

MAINTENANCE

STORAGE

When preparing the generator for storage, allow the unit to cool for 30 minutes then follow the guidelines below.

STORAGE TIME	PRIOR TO STORING
Less than 2 months	■ Drain petrol from tank and dispose of in a suitable container according to state and local ordinances.
2 months to 1 year	■ Drain petrol from tank and dispose of in a suitable container according to state and local ordinances.
1 year or more	■ Remove spark plug. ■ Drain petrol from tank and dispose of in a suitable container according to state and local ordinances. ■ Put a tablespoon of engine oil into the spark plug cylinder. Turn the engine slowly with the pull rope to distribute the engine oil. ■ Reinstall spark plug. ■ Change engine oil. ■ After removal from storage, fill with fresh petrol.
NOTE: If storing petrol in suitable container for later use, make sure petrol has been treated with fuel stabilizer according to stabilizer manufacturer's instructions.	

MAINTENANCE

MAINTENANCE SCHEDULE

NOTE: If a separate engine manual is provided for this generator, please follow the maintenance schedule provided in the engine manual instead of the maintenance information listed below.

	Before each use	After 1st month or 20 hours	Every 3 months or 50 hours	Every 6 months or 100 hours	Every year or after 300 hours
Check Engine oil	●				
Change Engine oil		●		●	
Check Air Filter	●				
Clean Air Filter			●		
Change Air Filter					●
Check/Adjust Spark Plug				●	
Replace Spark Plug					●
Check/Adjust Idle Speed					●
Clean Fuel Tank & Filter				●	
Check Fuel Hose	●				
Fuel Filter	Inspect				Replace
Check/Adjust Valve Clearance					●
Clean Spark Arrester				●	

NOTE: Maintenance should be performed more frequently when generator is used in dusty areas.

When generator has exceeded the maximum figures specified in the table, maintenance should still be cycled according to the intervals of time or hours stated herein.

TROUBLESHOOTING

ENGINE WILL NOT START

Possible Cause	Solution
Battery not charged.	Charge battery.
Engine switch is in the OFF position.	Turn engine switch to the ON position.
No fuel.	Fill fuel tank.
Stale gasoline or water in gasoline.	Drain entire system and refill with fresh fuel.
Engine oil level is low.	Engine is equipped with Low Oil Shutoff. If engine oil level is low, it must be filled before unit will start. Check engine oil level and fill, if necessary.
Multi-switch is in OFF or Run position.	Turn multi-switch to the START position.
Spark plug faulty, fouled, or improperly gapped.	Replace spark plug.
Engine stored without treating or draining gasoline, or refueled with bad gasoline.	Drain fuel. Refuel with fresh gasoline.
Dirty fuel filter.	Replace fuel filter or contact a qualified service center.
2 Wire Auto Switch is on	Switch off 2 Wire Auto Switch.

ENGINE LACKS POWER.

Possible Cause	Solution
Dirty air filter.	Check air filter element. Clean or replace as needed.
Engine stored without treating or draining fuel, or refueled with stale fuel.	Drain fuel. Refuel with fresh fuel. If problem continues, contact a qualified service center.

AC RECEPTACLE DOES NOT WORK.

Possible Cause	Solution
OUTPUT indicator is OFF, and OVERLOAD indicator is ON.	Check AC load. Stop and restart the engine. Check the cooling air inlet. Stop and restart the engine.
AC Circuit protector(s) tripped.	Check AC load and reset AC circuit protector(s)
GFCI system activated.	Reset the GFCI.
Item plugged in is defective.	Try a different item.

If problem persists after trying the above solutions, contact your nearest authorized service center for assistance.

WARRANTY INFORMATION

WARRANTY CONDITIONS

Thank you for purchasing a quality Maxwatt Power product.

Subject to the exclusions set out below.

Maxwatt Power Products PTY Ltd (the "Company") warrants that that this product will be free from defects in materials or workmanship for (2) years or (500) operating hours, whichever occurs first, from the date of original sale (hereinafter the "Warranty Period") in normal domestic applications such as personal, residential household or recreational use from the date of purchase.

A Warranty Period of (2) years or three hundred (300) operating hours, whichever occurs first, shall apply in commercial applications such as income producing, rental or other business-related use. Goods sold to a Consumer with an Australian Business Number shall be deemed as being used in a commercial application.

The Warranty Period is continuous from the date of original sale and does not restart upon the repair or replacement of the Goods or any part thereof.

The benefits conferred by this warranty are in addition to all rights and remedies which you may be entitled to under the Australian Consumer Law and any other statutory rights you may have under other applicable laws. This warranty does not exclude, restrict, or modify any such rights or remedies.

LIMITED WARRANTY

"This is a "walk in" warranty policy and is limited to the range of generators specified herein". We recommend that you take the generator to the nearest service agent for assistance. Please visit www.maxwatt.com.au for more information. Upon return – transportation charges shall be borne and prepaid by the Consumer – to the Company's or its nominated dealer's premises within the Warranty Period, the Company shall repair or replace, at its option, any Goods which it determines to contain defective material or workmanship and shall return said Goods to the Consumer free-on-board at the Company's or agent's premises. The repair or replacement work will be scheduled and performed according to the Company's normal workflow and availability of replacement parts.

The Company shall not be obligated, however, to repair or replace Goods which have been repaired by others; abused; improperly installed, operated, maintained, repaired, transported, or stored; not serviced to schedule using genuine spare parts; altered or otherwise misused or damaged in any way. This warranty does not apply where a defect or other issue with the product is caused by normal wear and tear, misuse, or abuse of this product.

WHAT THE APPOINTED SERVICE AGENT WILL REPAIR OR REPLACE UNDER WARRANTY:

"The appointed Service Agent will repair or replace, at its sole discretion, any part that is proven to be defective in material or workmanship under normal use during the applicable warranty time period. Warranty repairs will be made without any charge for parts and labour.

All parts replaced will be considered as part of the original product and the warranty on such parts will expire coincident with the original product warranty.

WARRANTY INFORMATION

EXCLUSIONS TO THIS LIMITED WARRANTY INCLUDE:

Neglect in the periodic maintenance as specified in the owner's manual.

Improper repairs or maintenance including any repairs and or maintenance carried out by a non-accredited service agent.

Operating methods other than those indicated in the owner's manual.

The use of non-genuine parts and or accessories other than those supplied by an accredited service agent.

Normal wear and tear including but not limited to the fading of painted or plated surfaces.

Consumable parts including but not limited to keys, spark plugs, fuel and oil filters, recoil starter ropes, wheels, lubricants, oil, grease, and fuel.

Cleaning adjustments and normal periodic maintenance work including but not limited to cleaning the battery, carburetor, engine oil, fuel tank and injectors.

Overloading resulting in the damage of the circuit breaker, stator and rotor.

Charging and proper maintenance of the battery.

Correct preparation when using the generator for the first time as set out in the owner's manual.

Fire damage because of but not limited to overloading, incorrect installation, incorrect re-fueling and any other causes as set out in the owner's manual.

Damage to any electronic and or electrical appliances connected to the generator.

BELOW IS A TABLE OF PARTS THAT ARE LIMITED BY THIS WARRANTY

BELOW TABLE OF PARTS THAT ARE LIMITED BY THIS WARRANTY:

PARTS	OUT OF BOX FAILURE (LESS THAN 20 RUNNING HOUR)
STATOR	x
ROTOR	x
CIRCUIT BREAKER	x
IGNITION COIL	x
SPARK PLUG	x
BATTERY	x

*NOTE:

OUT OF BOX FAILURE REFERS TO A MACHINE THAT HAS RUN FOR < 20 MINUTES.

WARRANTY INFORMATION

DISCLAIMER OF IMPLIED WARRANTIES

Maxwatt Power Products disclaims any responsibility for the loss of time or use of the product, transportation, commercial loss or any other incidental or consequential loss or damage. Any implied warranties are limited to the duration of this written limited warranty policy and procedures manual.

Proof of Purchase

It is recommended that you keep a copy of the original tax invoice for your records.

Warrantor

Name: Maxwatt Power Products Pty Ltd

Address: Unit 15/16 1440 New Cleveland Road Chandler 4155





Phone: 0737325363

Email: customercare@maxwatt.com.au

Web: www.maxwatt.com.au



























WARRANTY INFORMATION

Please Note the Following Terms & Conditions.

- ➔  — Customer is required to return the generator to the store.
- ➔  — The generator will be repaired at no charge to the customer should the fault be deemed a manufacturer defect only.
- ➔  — The approximate lead time for repairs is **14 - 21 working days** from the time the generator is received at the Maxwatt Service Center.
- ➔  — A copy of the proof of purchase is required when returning the generator for repairs. The warranty is null and void without a copy of proof of purchase.



NOTE: THE FOLLOWING IS EXCLUDED FROM THE MANUFACTURER WARRANTY POLICY.

-   — Neglect in the periodic maintenance as specified in the owners / operator's manual.
 -   — Operating methods other than those indicated in the owner / operator's manual.
 -   — Overloading resulting in the damage to the Inverter / Circuit Breaker / Alternator.
 -   — Improper repairs or maintenance carried out.
 -   — Normal "wear & tear" due to day-to-day use & operation.
 -   — The in-correct installation resulting in the damage to the Inverter / Alternator / Control Panel and remote.
-
- | | | | | | | | | |
|---|---|---|---|---|---|--|--|--|
|  |  |  |  |  |  |  |  |  |
|  |  |  |  |  |  | | | |

WARRANTY INFORMATION



CHECK LIST PRIOR TO SENDING THE GENERATOR IN FOR ASSESSMENT / REPAIR.



— Ensure that the battery is charged.



— Ensure that there is the correct amount of oil and that it does not need to be replaced.



— Ensure that there is sufficient fuel.



— Ensure that the spark plug does not need to be cleaned or replaced.



— Ensure that the generator **has been serviced** if it has run for more than 50 hours. Check the owners / operator's manual for information.



Distributed by: Maxwatt Power Products
Unit 15/16, 1440 New Cleveland Road, Chandler
Queensland
Australia

32082-06036-02